



# IntelliTouch Pool and Spa Control System



## User's Guide

IMPORTANT SAFETY INSTRUCTIONS  
READ AND FOLLOW ALL INSTRUCTIONS  
SAVE THESE INSTRUCTIONS



**© 2005 Pentair Water Pool and Spa, Inc. All rights reserved**

**This document is subject to change without notice**

1620 Hawkins Ave., Sanford, NC 27330 • (919) 566-8000  
10951 West Los Angeles Ave., Moorpark, CA 93021 • (805) 523-2400

**Trademarks and disclaimers**

IntelliTouch, EasyTouch, IntelliChlor, IntelliFlo, QuickTouch, MobileTouch, *SAm*, *SAL*, and *FIBERworks*, and the Pentair Water Pool and Spa logo are trademarks of Pentair Water Pool and Spa, Inc. Other trademarks and trade names may be used in this document to refer to either the entities claiming the marks and names or their products. Pentair Water Pool and Spa, Inc. disclaims proprietary interest in marks and names of others.



## Contents

|   |          |
|---|----------|
| Important Safety Precautions .....                                  | ii       |
| In this User's Guide .....  | vi       |
| Technical Support .....   | vi       |
| Related IntelliTouch Manuals .....                                  | vi       |
| Introduction .....  | 1        |
| IntelliTouch System Overview .....                                  | 1        |
| In the home .....   | 1        |
| Around the pool .....   | 1        |
| At the equipment pad .....  | 1        |
| IntelliTouch System Components .....                                | 2        |
| Load or Power Center .....  | 2        |
| IntelliTouch Personality Kits .....                                 | 2        |
| IntelliTouch Interfaces .....                                       | 3        |
| IntelliTouch in your home .....                                     | 4        |
| IntelliTouch Interface Kits .....                                   | 5        |
| PC Interface (iTC15 Kit - P/N 520500) .....                         | 5        |
| Personal Digital Assistant (PDA) (iTC25 Kit - P/N 520501) .....     | 5        |
| In-Wall Touch Screen (iTC35 Kit - P/N 520502) .....                 | 5        |
| Digital Wireless Tablet (iTC45 Kit - P/N 520503) .....              | 5        |
| IntelliTouch ScreenLogic Interface Accessory Kits .....             | 5        |
| <b>USING INTELLITOUCH CONTROLLERS FOR EVERYDAY OPERATIONS .....</b> | <b>7</b> |
| Main Screen (Indoor Control Panel and MobileTouch) .....            | 8        |
| Menu Settings and Descriptions .....                                | 9        |
| Indoor Control Panel Menu Tree .....                                | 10       |
| General Pool and Spa Operations .....                               | 11       |
| Heating your Spa and Pool .....                                     | 11       |
| Adjust Spa or Pool Heat Settings .....                              | 11       |
| Configuring the Heating System Options .....                        | 12       |
| Switching on Lights Manually .....                                  | 13       |
| Special Lighting Features .....                                     | 14       |
| Dim Lights .....  | 15       |
| Set ON/OFF Times for Equipment .....                                | 16       |
| Using the Once Only Timer .....                                     | 17       |
| Setting the Egg Timer Function .....                                | 18       |
| iS10 Spa-Side Remote Controller .....                               | 19       |
| iS4 Spa-Side Remote Controller .....                                | 20       |
| MobileTouch Wireless Controller .....                               | 21       |
| Charging the MobileTouch Wireless Controller .....                  | 22       |
| Using the MobileTouch Wireless Controller .....                     | 22       |
| QuickTouch Wireless QT4 Remote Controller .....                     | 23       |

## Contents (Continued)

|  |           |
|--|-----------|
| <b>PREPARING THE SYSTEM FOR INITIAL START-UP .....</b>                                 | <b>25</b> |
| Setting up the IntelliTouch System .....   | 26        |
| Automatically Enabled Wired Controllers .....  | 28        |
| Adding Multiple Controllers and Expansion Centers .....                                | 28        |
| Adding a MobileTouch Wireless Controller .....   | 28        |
| Testing the Indoor Control Panel and MobileTouch Controller .....                      | 28        |
| Manually Enabling Wired Controllers and Remotes .....                                  | 29        |
| Assigning Additional Expansion Centers .....   | 30        |
| Enabling a MobileTouch Wireless Controller .....                                       | 31        |
| Adding an iS10 Spa-Side Remote Controller .....  | 33        |
| Prepare the System for Operation .....   | 34        |
| Check the Main Load Center .....   | 34        |
| Checking the Indoor Control Panel or MobileTouch .....                                 | 36        |
| Setting up the IntelliTouch System using the Indoor Control Panel or MobileTouch ..... | 37        |
| The Preference Screen Options .....  | 37        |
| Set the System Clock .....   | 38        |
| Assigning Circuit Names to Display 1 (or Display 2, 3, and 4) .....                    | 39        |
| About DISPLAY Screen 1, 2, 3, 4 .....  | 39        |
| Assigning Circuit Names .....  | 40        |
| Labeling Circuit Buttons in the Load Center .....                                      | 40        |
| IntelliTouch Circuit Names .....   | 40        |
| Creating Custom Names for Auxiliary Circuits .....                                     | 42        |
| Assign Circuit Functions and Freeze Protection .....                                   | 43        |
| Freeze Protection .....  | 43        |
| Assigning Circuit Functions and Freeze Protection .....                                | 43        |
| Special Function to a Circuit .....  | 44        |
| Setting up Lighting Options (Color Set and Color Swim) .....                           | 45        |
| Color Set and Color Swim .....   | 45        |
| Setting up Set Colors and Color Swim with SAM, SAL, or FIBERworks .....                | 47        |
| Setting up Equipment .....   | 48        |
| Manual Priority Override of Timed Program Circuits .....                               | 48        |
| Setup Solar Equipment and Heatpump Option .....  | 49        |
| Setting up a 2-Speed Pump .....  | 50        |
| Set a Cool-Down Cycle for the Heater .....   | 50        |
| Delay Cancel Feature .....   | 51        |
| Set Automatic Spa Heating When the Spa is Manually Switched On .....                   | 52        |
| Changing the Display to Show Fahrenheit to Celsius .....                               | 52        |
| Chlorine Generator .....   | 53        |
| Activate the Chlorinator Control Interface .....                                       | 53        |
| Changing the Chlorinator Output .....  | 54        |
| Super Chlorinate the Pool .....  | 54        |
| Configuring Valve Actuators (Controlled by AUX or Feature Circuit) .....               | 55        |
| Configuring Valve Actuators .....  | 55        |

## Contents (Continued)

|  |           |
|--|-----------|
| Feature Circuits .....   | 56        |
| Assign a Circuit Name to a Feature Circuit (not available for model i5 or i5s) .....           | 56        |
| Create a Macro .....   | 57        |
| Configuring Remote Control Button Circuits (iS4, iS10, QT4 QuickTouch, and Phone Remote) ..... | 58        |
| Setting up the Remote Control Telephone Feature .....  | 59        |
| Disable/Enable Spa-Side Remote .....   | 60        |
| Calibrating Temperature Sensors .....  | 62        |
| Using the Service Personnel Screen .....   | 63        |
| Checking Firmware Version .....  | 63        |
| Manually Updating Between Indoor and Outdoor Control Panels .....                              | 64        |
| Erasing the System Memory .....  | 65        |
| Manually Enable an Indoor Control Panel .....  | 66        |
| About DISPLAY Screen 1, 2, 3, 4 .....  | 66        |
| System Worksheet Overview .....  | 67        |
| The Main Outdoor Control Panel .....   | 74        |
| Shared Equipment Systems i5, i7+3, i9+3 .....  | 74        |
| Erasing Outdoor Control Panel Memory (Factory Default) .....                                   | 76        |
| System Start-Up .....  | 78        |
| Check Electronics .....  | 78        |
| System Test .....  | 78        |
| Testing the Auxiliary Relays .....   | 78        |
| <b>TROUBLESHOOTING .....</b>   | <b>79</b> |
| Frequently Asked Questions (FAQ) .....   | 79        |
| What does the '+3' on some of the systems mean? .....  | 79        |
| How Do I Setup/Configure/Program the 2-Speed Pump? .....                                       | 79        |
| Can I turn the Heater On and Change the temperature from the Spa? .....                        | 79        |
| How do I get Solar to switch on? .....   | 79        |
| What are Color Swim and Color Set? .....   | 80        |
| How do I get SAm/SAL/PG2000 to Synchronize? .....  | 80        |
| Can I copy a standard configuration to all the systems I install? .....                        | 80        |
| Fixing mismatched system personalities .....   | 81        |
| Indoor Control Panel and Outdoor Control Panel Connection Problem .....                        | 81        |
| MobileTouch Temperature Readout Not Accurate (20 to 30 Degrees off) .....                      | 81        |
| System Problem Diagnosis .....   | 82        |
| Problem: The system works in Service Mode, but Indoor Control Panel fails to operate. ....     | 82        |
| Problem: Indoor and Outdoor Control Panels work, but iS4 fails to operate. ....                | 83        |
| Problem: Indoor and Outdoor Control Panels work, but iS10 fails to operate. ....               | 84        |
| Problem: The Mobile Control Panel will not work, or will not work dependably. ....             | 85        |
| Problem: The Quick Touch remote will not work, or will not work dependably. ....               | 86        |
| Wiring IntelliTouch to a Salt Chlorine Generator .....   | 90        |
| <b>Glossary .....</b>  | <b>91</b> |

# IMPORTANT SAFETY PRECAUTIONS



## Important Notice:

**Attention Installer:** This manual contains important information about the installation, operation and safe use of this product. This information should be given to the owner and/or operator of this equipment.

**⚠ WARNING** - Before installing this product, read and follow all warning notices and instructions which are included. Failure to follow safety warnings and instructions can result in severe injury, death, or property damage. Call (800) 831-7133 for additional free copies of these instructions.

**⚠ WARNING** - Water temperature in excess of 100 degrees Fahrenheit may be hazardous to your health. Prolonged immersion in hot water may induce hyperthermia. Hyperthermia occurs when the internal temperature of the body reaches a level several degrees above normal body temperature of 98.6° F (37° C). The symptoms of hyperthermia include drowsiness, lethargy, dizziness, fainting, and an increase in the internal temperature of the body.

The effects of hyperthermia include: 1) Unawareness of impending danger. 2) Failure to perceive heat. 3) Failure to recognize the need to leave the spa. 4) Physical inability to exit the spa. 5) Fetal damage in pregnant women. 6) Unconsciousness resulting in danger of drowning.

**⚠ WARNING** - To reduce the risk of injury, do not permit children to use this product unless they are closely supervised at all times.

**⚠ WARNING** - **The use of alcohol, drugs, or medication can greatly increase the risk of fatal hyperthermia in hot tubs and spas.**

**⚠ WARNING** - Control System is intended to control heaters with built-in high limit circuits **ONLY**. Failure to do so may cause property damage or personal injury.

**⚠ WARNING** - Do not use this product to control an automatic pool cover. Swimmers may become entrapped underneath the cover.

**⚠ WARNING** - For units intended for use in other than single-family dwellings, a clearly labeled emergency switch shall be provided as part of the installation. The switch shall be readily accessible to the occupants and shall be installed at least 10 feet (3.05 m) away, adjacent to, and within sight of, the unit.

**⚠ CAUTION** - Except for listed spa-side remote controls, install a minimum of five (5) feet from the inside wall of the pool and spa.

## IMPORTANT SAFETY PRECAUTIONS (CONTINUED)

**⚠ FCC Regulatory Safety Notice** - The MobileTouch wireless control panel device has been tested and found to comply with the limits for a Class B digital device, pursuant to Part 15 of the FCC Rules. These limits are designed to provide reasonable protection against harmful interference in a residential installation. This device generates, uses and can radiate radio frequency energy and, if not installed and used in accordance with the instructions, may cause harmful interference to radio communications. However, there is no guarantee that interference will not occur in a particular installation. If this equipment does cause harmful interference to radio or television reception, which can be determined by turning the equipment off and on, the user is encouraged to try to correct the interference by one or more of the following measures:

- Reorient or relocate the receiving antenna.
- Increase the separation between the equipment and receiver.
- Connect the equipment into an outlet on a circuit different from that to which the receiver is connected.
- Consult the dealer or an experienced radio/TV technician for help.
- Modifications not expressly approved by the party responsible for FCC compliance could void the user's authority to operate the equipment.

### General Installation Information

1. All work must be performed by a licensed electrician, and must conform to the National Electric Code and all national, state, and local codes.
2. Install to provide drainage of compartment for electrical components.
3. If this system is used to control underwater lighting fixtures, a ground-fault circuit interrupter (GFCI) must be provided for these fixtures. Conductors on the load side of the ground-fault circuit-interrupter shall **not** occupy conduit, junction boxes or enclosures containing other conductors unless such conductors are also protected by a ground-fault circuit-interrupter. Refer to local codes for details.
4. A terminal bar stamped  is located inside the supply terminal box. To reduce the risk of electric shock, this terminal must be connected to the grounding means provided in the electric supply service panel with a continuous copper wire equivalent in size to the circuit conductors supplying this equipment (no smaller than 12 AWG or 3.3 mm). The bonding lug(s) provided on this unit are intended to connect a minimum of one No. 8 AWG for US installation and two No. 6 AWG for Canadian installations solid copper conductor between this unit and any metal equipment, metal enclosures or electrical equipment, metal water pipe, or conduit within 5 feet (1.5 m) of the unit.
5. The electrical supply for this product must include a suitably rated switch or circuit breaker to open all ungrounded supply conductors to comply with Section 422-20 of the National Electrical Code, ANSI/NFPA 70.1987. The disconnecting means must be readily accessible to the tub occupant but installed at least 10 ft. (3.05 m) from the inside wall of the pool.
6. Supply conductor must be sized to support all loads. Maximum supply conductor current must be 125 Amps at 125 VAC or 63 Amps at 240 VAC.

## In this User's Guide

This manual describes the how to operate the IntelliTouch system to control pool pumps, heaters, spa lights, and other functions. Described are basic everyday operations that can be easily automated, to the advanced setup functions that only need to be performed once.

This manual consists of the following sections:

|   |           |
|---|-----------|
| Using IntelliTouch IntelliTouch Controllers for Everyday Operations | (page 7)  |
| Preparing the System for Initial Start-Up                           | (page 17) |
| Toubleshooting  | (page 79) |
| Glossary  | (page 91) |

## Technical Support

Contact Technical Support at:

**Sanford, North Carolina** (8 A.M. to 5 P.M.)

Phone: (800) 831-7133

Fax: (919) 566-8920

**Moorpark, California** (8 A.M. to 5 P.M.)

Phone: (800) 831-7133 (Ext. 6502)

Fax: (805) 530-0194

## Web sites

visit [www.pentairpool.com](http://www.pentairpool.com) and [staritepool.com](http://staritepool.com)

## Related IntelliTouch Manuals

|   |              |
|---|--------------|
| IntelliTouch Personality Kit User's Guide                   | (P/N 520101) |
| IntelliTouch Load Center and Power Center User's Guide      | (P/N 520100) |
| IntelliTouch Expansion Center Kit User's Guide              | (P/N 520471) |
| IntelliTouch i-Link Protocol Interface Adapter User's Guide | (P/N 520450) |



## Introduction

Welcome! Your Pentair IntelliTouch Pool and Spa and control system will change the way you view pool and spa controls. This innovation in pool and spa automation offers complete freedom for you while having full automation control over your pool, spa, lights, heater, cleaners and much more. You can now schedule multiple start and stop times to control your lights, heater, spa jets, and filter pumps. Using the Indoor Control Panel or MobileTouch wireless control panel you can control your pool, spa, and lights from anywhere inside or outside your home. Optional controllers are also available such as the wireless Digital Tablet or Personal Digital Assistant (PDA), and in-wall Touch Screen that can interface with your PC. IntelliTouch is a scalable system that can be upgraded to a completely integrated home automation solution including audio, security, climate, irrigation and more. For more information about using these interfaces, refer to IntelliTouch ScreenLogic system.

This manual describes how to install, configure, and operate the IntelliTouch system. Before learning how the IntelliTouch system works, familiarize yourself with the various wireless and wired controllers.

## IntelliTouch System Overview

IntelliTouch systems offer the flexibility to handle from 5 to 40 circuits (high voltage relays) that can be used to control any combination of pumps, lights, water features, etc. As an added benefit, user-configurable circuits can also be used to control these combinations of features and more. The Feature Macro circuits feature allows any number of circuits to be combined on a single button. This gives you the ability to set up “themes” with custom names all with a press of a button. *(Not available with IntelliTouch model i5 or i5S).*

IntelliTouch users can also dim any high voltage incandescent light such as Pentair Amerlites and SpaBrites up to eight levels using the IntelliTouch Dimmer Module (P/N 520406). The dimmer module supports multiple lights from 100 watts up to 1,000 watts and installs in a standard relay location. Any number of dimmers (up to 10 maximum) may be used with a maximum combined load of 4,000 W in a single Load Center.

### In the home

The IntelliTouch system can utilize multiple wired and wireless controllers including the Digital Tablet, Personal Digital Assistant (PDA), the wired in-wall Touch Screen, Indoor Control Panel, and the wireless MobileTouch control panel, and even your existing home PC. A maximum of four ScreenLogic interfaces can be used. For example, four Tablets, or four PDA's, or four in-wall Touch Screen's, or four PC's in any combination.

### Around the pool

Located near your spa, the IntelliTouch, iS10 or iS4 spa-side remote provide control buttons for various pool and spa functions. The iS10 spa-side remote also provides a temperature display.

### At the equipment pad

Near the pump, filter, and other equipment will be located a metal box known as the Load Center or Power Center. This is where high voltage from the circuit breaker panel junction box at the home is distributed to the IntelliTouch Load Center or Power Center. The pool service person can periodically check pool operations from this unit. The Load Center is also where the various IntelliTouch controllers interface with the other equipment.

Mounted on or top the valves you may also find motorized valve actuators used to change the flow of water through the plumbing. There are also temperature sensors and cable that connect to the heater. There should be no need for anyone other than your service person to periodically check this equipment.

## IntelliTouch System Components

The main required components of an IntelliTouch system are the Load or Power Center, IntelliTouch Personality Kits, and the Interfaces:

### Load or Power Center

- **Load Center:** Provides a larger footprint (17" W x 23" H) Includes built-in sub panel (125 AMPS) capable of holding up to eight 1" breakers. Also includes five 25 AMP three HP relays, 110/240 V transformer with secondary side circuit protection. Multiple knockouts for different sizes of conduit are supplied as well as a GFCI side knockout. The Load Center provides ample space for all high and low voltage wiring needs.
- **Power Center:** Offers a smaller footprint (17" W x 17" H) than the Load Center. The Power Center does not include a circuit breaker base. Users should choose this enclosure if they already have existing circuit breakers/sub-panel for their equipment.
- **Expansion Kits:** Models i5X and i10X, offer five or ten additional Auxiliary Circuits for systems i9+3, i9+3S and i10+3D. Each IntelliTouch Expansion Kit requires a Load Center (P/N 520136) or Power Center (P/N 520137). Up to three Expansion Kits and Load or Power Centers may be added to a system, for control of up to 38 Auxiliary Circuits (40 auxiliary circuits for i10+3D).

### IntelliTouch Personality Kits

There are several types of IntelliTouch control systems available for different pool/spa configurations:

- **Shared Equipment: Pool and spa combinations with shared filtration system** – Pool owners can enjoy the convenience of motorized valves for water flow separation between pool and spa. The Personality Kit models are:
  - **i5 (P/N 520505)** – Four auxiliary circuits plus filter pump operation. Five relays are included in the Load Center.
  - **i7+3 (P/N 520507)** – Six auxiliary circuits plus filter pump operation and the +3 option (create a Feature circuit for valve actuators without using an existing output auxiliary circuit, and special light functions for color lighting). Two relays are included in the kit and five in the Load Center.
  - **i9+3 (P/N 520509)** – Eight auxiliary circuits plus filter pump operation and the +3 option (create a Feature circuit for valve actuators without using an existing output auxiliary circuit, and special light functions for color lighting). Four relays are included in the kit and five in the Load Center.
- **Dual Equipment: Pool and Spa with Dual Sets of Equipment** – The IntelliTouch i10+3D (P/N 520510) system provides advanced automation for a pool and spa using two separate sets of equipment. This IntelliTouch Personality Kit can control up to 10 pumps and/or lighting circuits, plus two heater circuits. The Personality Kit includes, eight auxiliary circuits plus a filter pump. The +3 option (create a Feature Macro circuit for valve actuators without using an existing output auxiliary circuit). Five relays are included in the kit and five in the Load Center. You can create a Feature circuit for valve actuators without using an existing output auxiliary circuit, and special light functions for color lighting. This model also allows Hi/Low Temperature settings.
- **Single Equipment: Pool Only or Spa Only Applications** – The IntelliTouch i5S (P/N 520506) and i9+3S provide advanced automation for a single body of water. The i5S (P/N 520506) Personality Kits includes eight auxiliary circuits plus filter pump operation. Five relays in the Load Center. The i9+3S (P/N 520508) Personality Kits includes four auxiliary circuits plus filter pump operation and the +3 option (create a Feature Macro circuit for valve actuators without using an existing output aux circuit). Four relays are included in the kit and five in the Load Center. You can create a Feature circuit for valve actuators without using an existing output auxiliary circuit, and special light functions for color lighting. This model also allows Hi/Low Temperature settings.

## IntelliTouch Interfaces

Pool and Spa owners can choose one or more of the following interface options to control the IntelliTouch system throughout their home.

- **iTC15 Kit (P/N 520500)** – Includes Protocol Interface Adapter and wireless router that connects to existing Desktop or Laptop PC. This allows control of IntelliTouch pool and spa systems via PC (requires PC with an Ethernet connection, and Windows XP operating system).
- **iTC25 Kit (P/N 520501)** – Includes Wireless Personal Digital Assistant (PDA) with 3.5" color touch screen custom configured for IntelliTouch systems, wireless router, and a Protocol Interface Adapter.
- **iTC35 Kit (P/N 520502)** – Includes in-wall color touch screen with Ethernet (RJ45) connection and Protocol Interface Adapter and wireless router. The in-wall Touch screen is custom configured for IntelliTouch systems. Requires an Ethernet cable to router.
- **iTC45 Kit (P/N 520503)** – Includes wireless Tablet with color touch screen, Protocol Interface Adapter, and wireless router. The Tablet is custom configured for IntelliTouch systems.
- **Indoor Control Panel (P/N 520138)** – 3.75" monochrome backlit LCD control panel. Connects to the Personality board in the Load Center.
- **MobileTouch (P/N 520340)** – 3.75" monochrome backlit LCD wireless control panel with transceiver antenna . Allows any IntelliTouch wired system to also have a wireless remote with all the capabilities of the Indoor Control Panel. With an average range of 300 feet, pool owners have system control anywhere around the home or yard. Powered by a rechargeable lithium-ion battery. Includes an AC adapter for recharging.
- **QuickTouch Wireless Remote (QT4):** Four-function wireless remote for pool and spa functions of your choice. This radio transmitter operates up to 150 feet range from the Load Center or Power Center.
- **iS10 and iS4:** 10-function (iS10) and 4-function (iS4) Spa-Side remote controller for pool and spa functions of your choice. The controllers can operate up to 150 feet range from the Load or Power Center.
- **i-Link Protocol Interface Adapter:** Connects to wireless router via Ethernet connection and to Personality board (Load Center or Power Center) via Serial cable (Four-wire).



PDA



In-Wall Touch Screen



Digital Tablet



Indoor Control Panel



i-Link Protocol Interface Adapter



MobileTouch Wireless Controller



QuickTouch wireless remote (QT4)

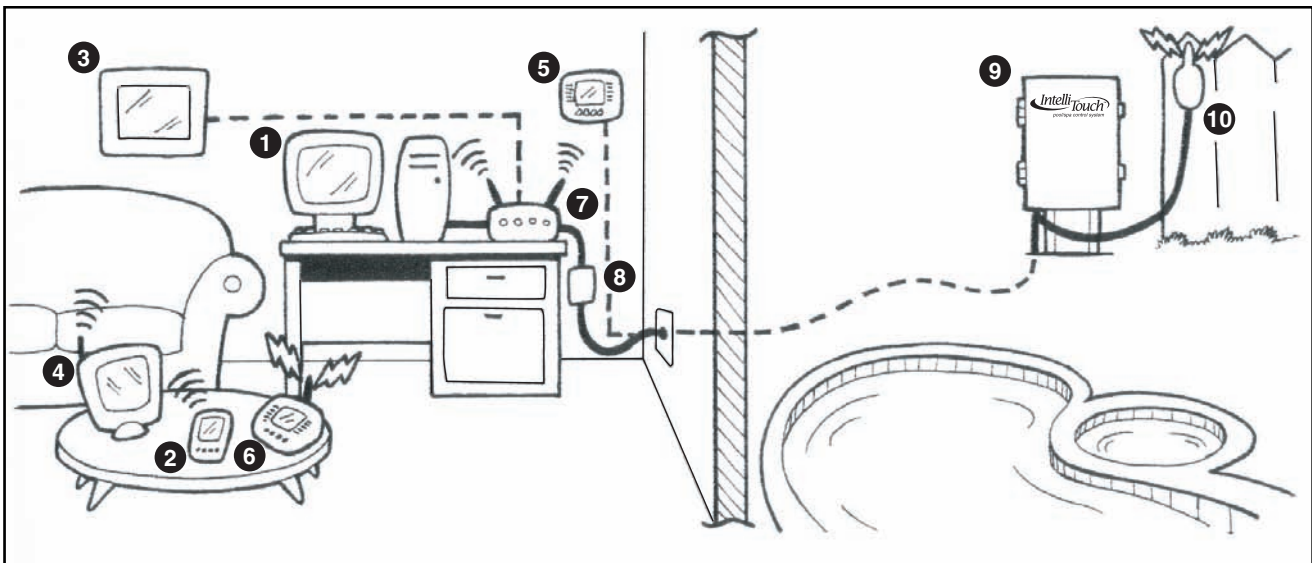

## IntelliTouch in your home

- 1 **Personal Computer (PC):** Existing home owner's PC or Laptop. Connects to a wireless router and the IntelliTouch Protocol adapter for control of IntelliTouch pool/spa systems. Requires a PC/Laptop (Windows XP) with Ethernet/RJ45 adapter installed.
- 2 **Personal Digital Assistant (PDA):** This wireless PDA with a color touch screen enables you to control your pool and spa features using the IntelliTouch ScreenLogic interface. The PDA is custom configured for IntelliTouch systems.
- 3 **In-wall Touch Screen:** A color display with Ethernet (RJ45) connector. Connects to the provided wireless router and Protocol adapter via Ethernet (RJ45) for control of IntelliTouch pool and spa systems. The in-wall Touch Screen is custom configured for IntelliTouch systems.
- 4 **Wireless Tablet:** This control panel consists of a color touch screen. Receives and transmits commands via wireless router and Protocol adapter for control of IntelliTouch pool/spa systems. The Tablet is custom configured for IntelliTouch systems.
- 5 **Indoor Control Panel:** This control panel consists of a 3.75" monochrome backlit LCD and connects to the Personality Board in the Load Center or Power Center for control of IntelliTouch pool and spa systems.
- 6 **MobileTouch:** This wireless control panel has a 3.75" monochrome backlit LCD. Receives and transmits commands via the Transceiver antenna located at the Load or Power Center.
- 7 **Wireless router:** Connects to the PC or Laptop via Ethernet connection to the Protocol adapter.
- 8 **Protocol adapter:** Connects to wireless router via Ethernet connection and to Personality board (Load/Power Center) via a four-wire 22-AWG cable.
- 9 **Load Center or Power Center.** The main control center. Includes the Outdoor Control Panel that controls pump, heater, and light relays. Receives commands via Protocol adapter, and wireless and wired control panels connected to the Personality board.
- 10 **MobileTouch Transceiver antenna:** This antenna is connected to the Personality board. Sends and receives commands to and from the MobileTouch control panel.

## IntelliTouch Interface Kits

The following items are included in your IntelliTouch interface kit. If any item is missing or damaged in the IntelliTouch kit, contact your authorized dealer, or contact Pentair Water technical support.

### PC Interface (iTC15 Kit - P/N 520500)

- Protocol adapter for use with existing Desktop or Laptop PC
- Wireless router (802.11b/g) with AC adapter
- IntelliTouch ScreenLogic User's Guide
- CD-ROM containing IntelliTouch ScreenLogic PC user interface software

### Personal Digital Assistant (PDA) (iTC25 Kit - P/N 520501)

- Personal Digital Assistant (PDA) with built-in Wi-Fi 802.11b wireless LAN adapter with antenna. Refer to the manufacturers documentation for kit contents
- Wireless router (802.11b/g) with AC adapter
- Protocol adapter
- IntelliTouch ScreenLogic User's Guide
- CD-ROM containing IntelliTouch ScreenLogic PC user interface software

### In-Wall Touch Screen (iTC35 Kit - P/N 520502)

- In-wall Digital Tablet, and AC adapter
- Wireless router (802.11b/g) with AC adapter
- Protocol adapter
- IntelliTouch ScreenLogic User's Guide
- CD-ROM containing IntelliTouch ScreenLogic PC user interface software

### Digital Wireless Tablet (iTC45 Kit - P/N 520503)

- Digital Tablet (with internal battery pack), stylus, built-in Wi-Fi 802.11b wireless LAN adapter with antenna.
- Wireless router (802.11b/g) with AC adapter
- Protocol adapter
- IntelliTouch ScreenLogic User's Guide
- CD-ROM containing IntelliTouch ScreenLogic PC user interface software

## IntelliTouch ScreenLogic Interface Accessory Kits

Up to a total of four ScreenLogic interfaces can be used with an IntelliTouch system, as shown above. If you need additional interfaces, first order one of the ScreenLogic interface kits, then order one or more of the following accessory interfaces accessory kits:

- PDA, CD-ROM and manual (P/N 520497)
- In-Wall Touch Screen, CD-ROM and manual (P/N 520498)
- Tablet, CD-ROM and manual (P/N 520499)

*Note: The above Accessory Kits interfaces do not include a Protocol adapter or wireless router.*





## **Using IntelliTouch Controllers for Everyday Operations**

## Main Screen (Indoor Control Panel and MobileTouch)

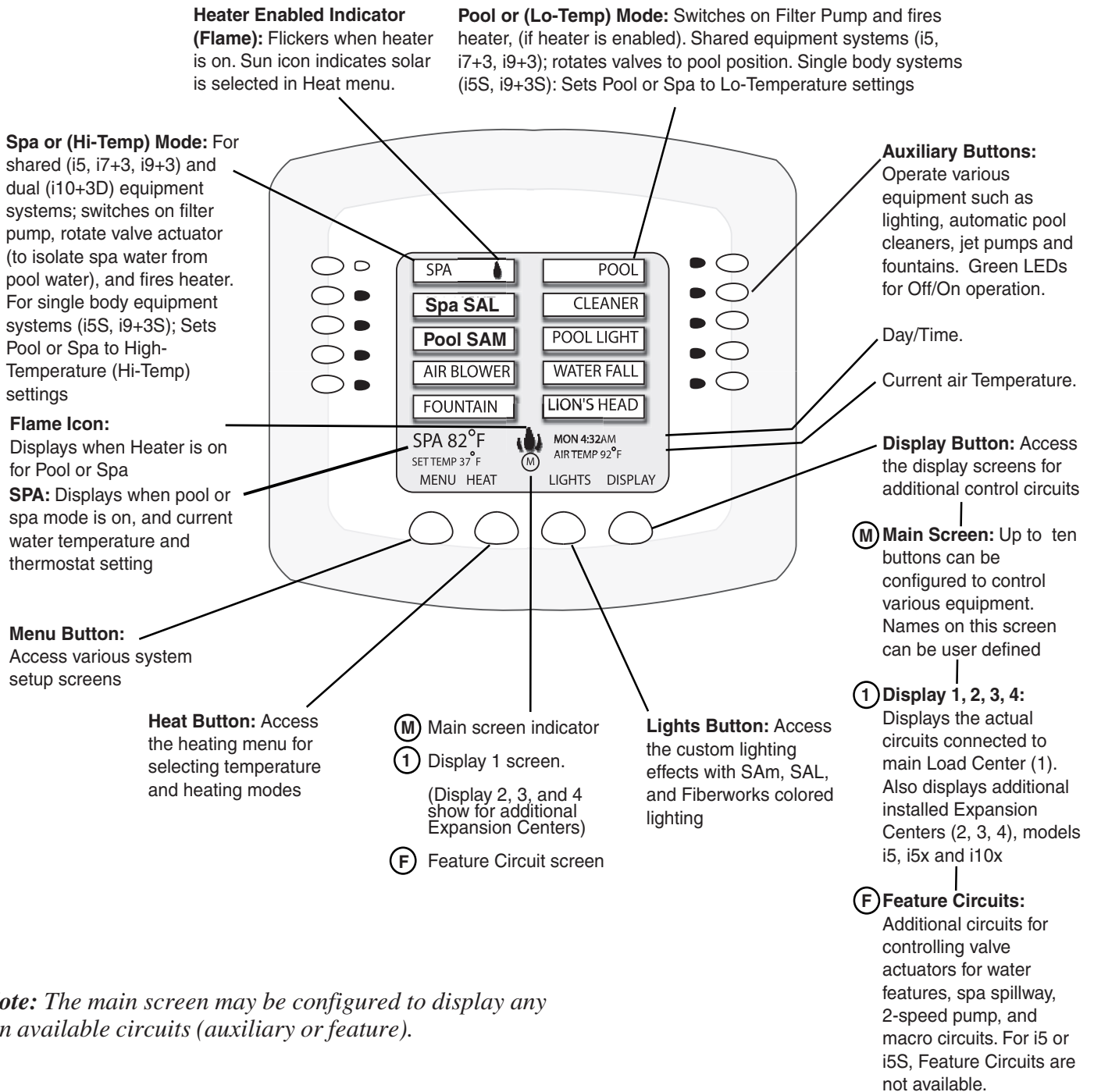

**Note:** The main screen may be configured to display any ten available circuits (auxiliary or feature).



# Menu Settings and Descriptions

Use the IntelliTouch menu selections to setup the system up to automatically control general day-to-day pool and spa operations. As shown below, to setup pool and spa schedules, press **MENU > PROGRAM**. To configure system equipment, press **MENU > SETUP** or **MENU > SETUP > ADVANCED**.

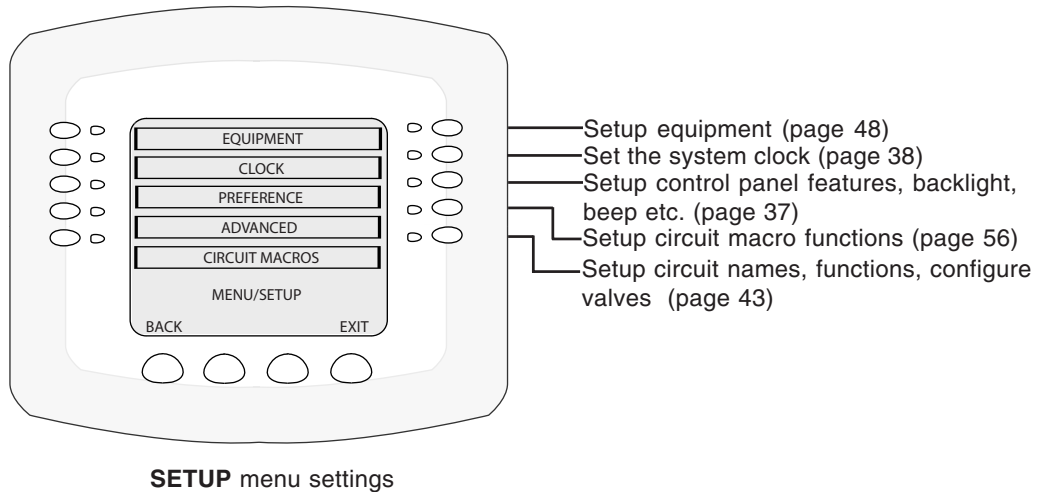
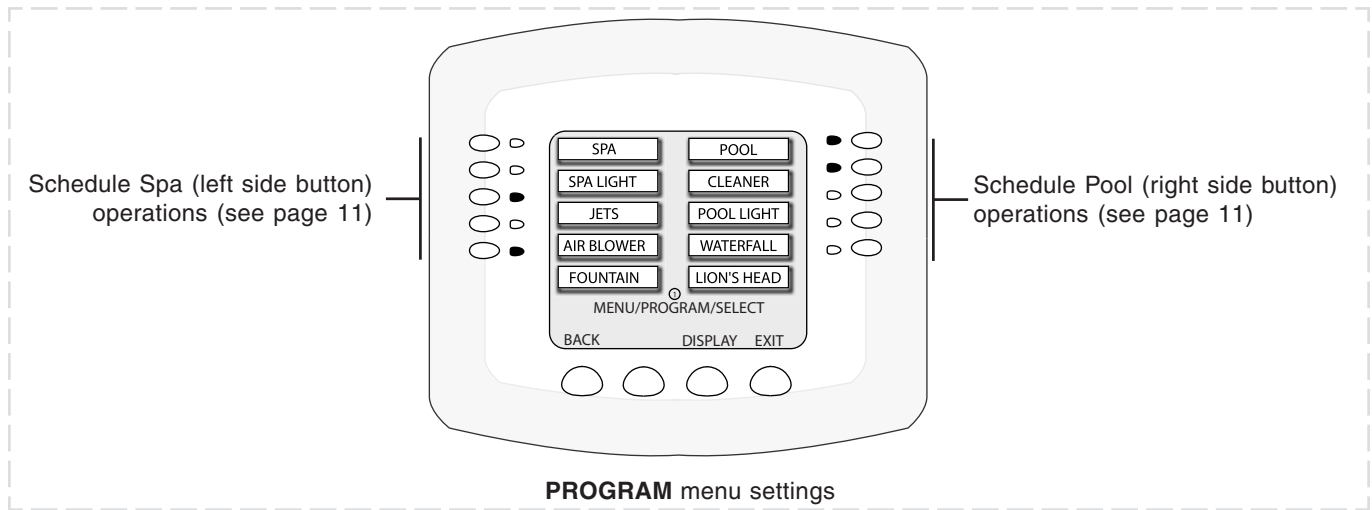
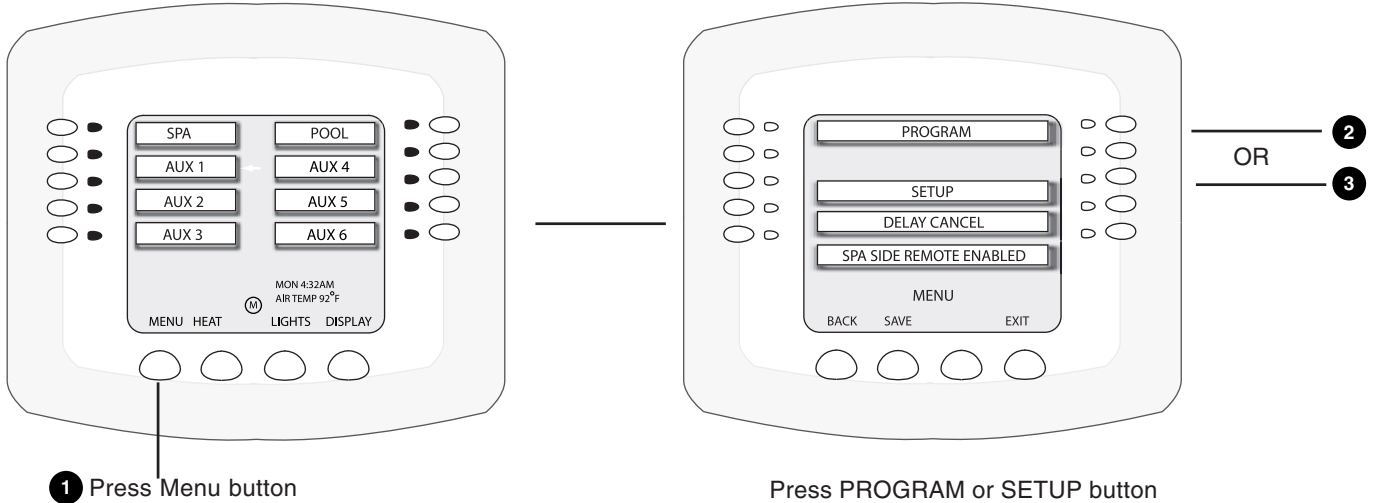

# Indoor Control Panel Menu Tree

Buttons:

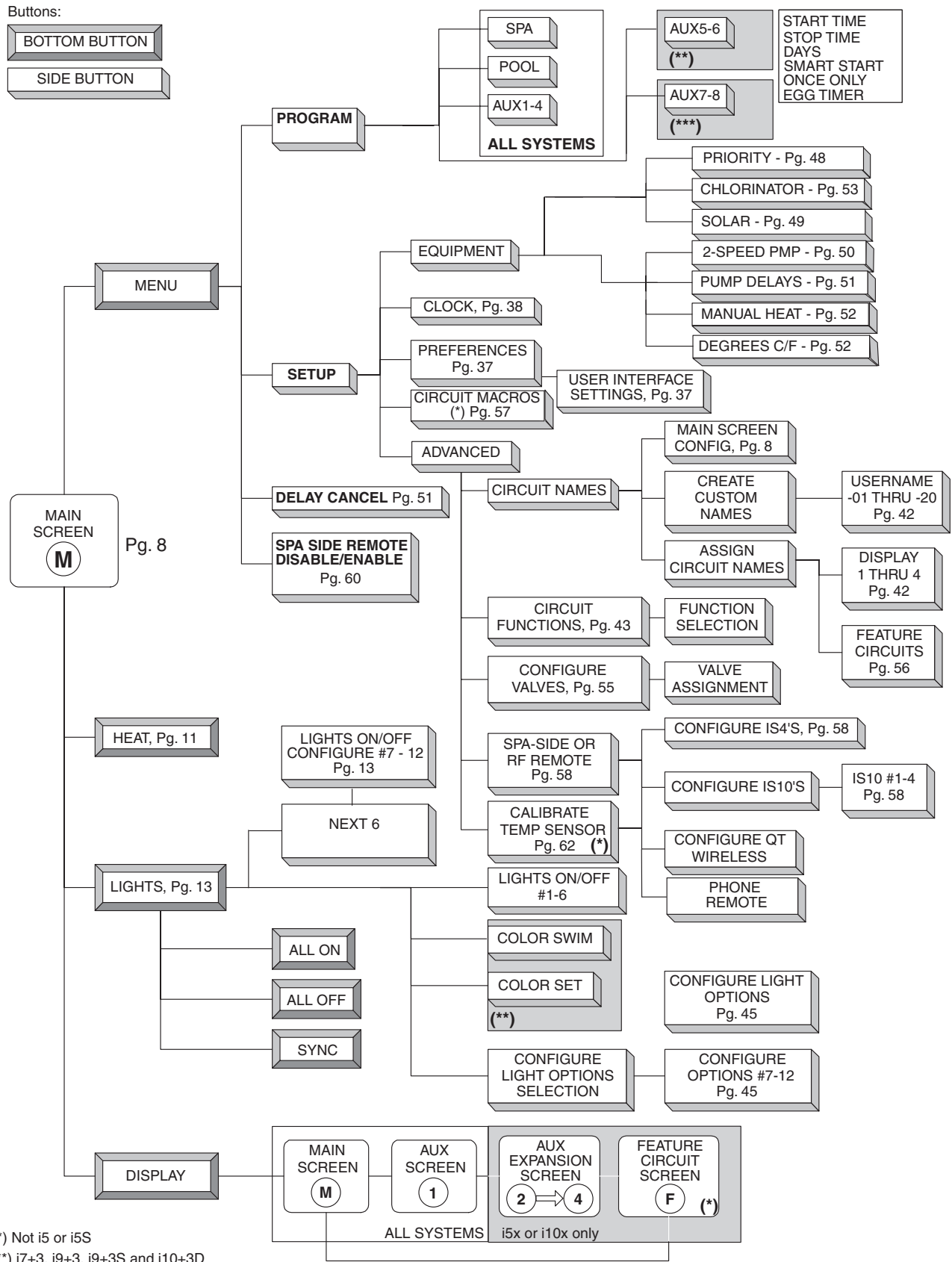
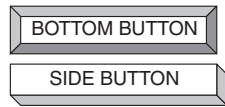

(\*) Not i5 or i5S  
 (\*\*) i7+3, i9+3, i9+3S and i10+3D  
 (\*\*\*) i9+3, i9+3S and i10+3D

## General Pool and Spa Operations

The following describe some of the general day-to-day pool and spa operations.

### Heating your Spa and Pool

From the Heat screen, use **Spa** button (left side) or **Pool** button (right side) to adjust the heat temperature for your pool or spa. You can also switch the heater on or off from this screen. For single-body systems (models i5S and i9+3S), spa and pool are replaced with **Hi-Temp** and **Lo-Temp** settings.

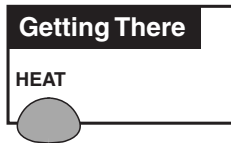

### Adjust Spa or Pool Heat Settings

To adjust the spa or pool set point temperature, go to the **Heat** screen:

*Note: Be sure the **Spa Mode** label does not say OFF. If it displays OFF, refer to “Configuring the Heating System Options,” page 12, for more information.*

To adjust the spa or pool set point temperature, press the **HEAT** button at the bottom of the screen:

- **SPA:** Press the spa **Up** or **Down** buttons (top left and right side) to increase or decrease the spa temperature. The set point water temperature is displayed in the middle of the screen.
  - **POOL:** Press the pool **Up** or **Down** buttons (third down from the top, left and right side) to increase or decrease the pool temperature. The set point water temperature is displayed in the middle of the screen.
1. Press the **Set** button to save the temperature settings. The current spa and pool water temperatures are displayed on the main screen.
  2. Press the **Back** button to return to the Main screen.

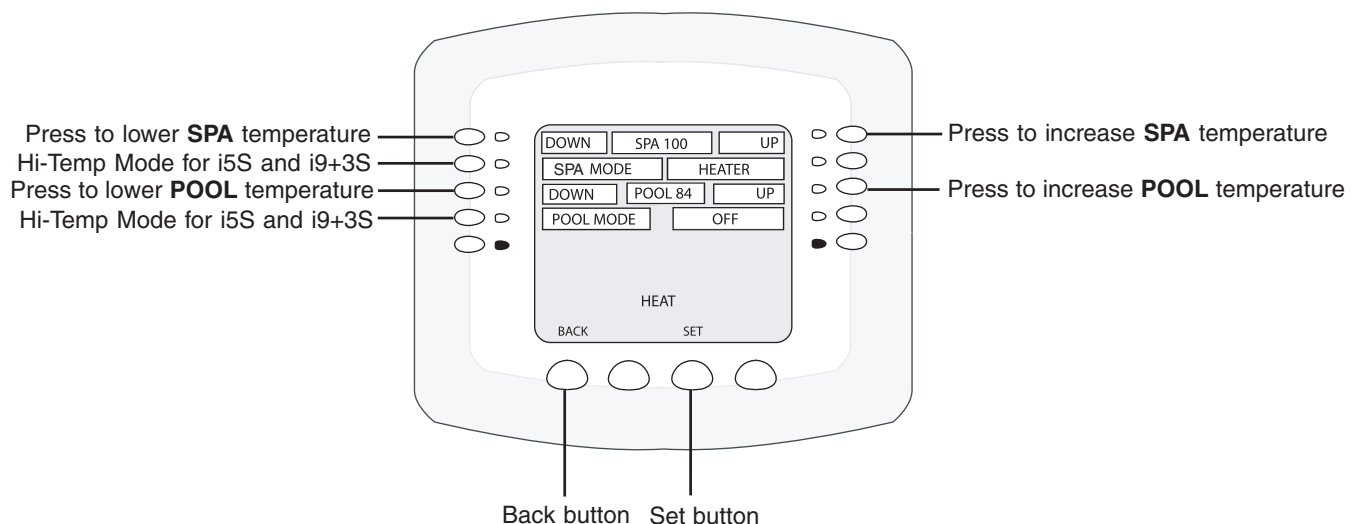

## Configuring the Heating System Options

The IntelliTouch system allows for many different pool and spa heating options. In some instances, more than one heating system may be installed. The system can then automatically select the heating system that is most effective for your settings. However, before the system can take advantage of these options the system must be told what kind of heating systems are installed.

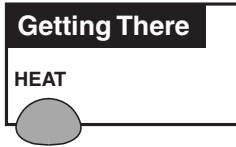

To configure the heating system options, press the **HEAT** button at the bottom of the screen.

- **SPA:** Press the second button from the top (SPA MODE) to select the heating mode.
  - **POOL:** Press the third button from the top (POOL MODE) to select the heating mode.
1. Press the **Set** button to save the heat settings.
  2. Press the **Back** button to return to the Main screen.

The heat options are:

- **OFF** - No heating even though pump and other circuits may be operating.
- **HEATER** - Gas heater only.
- **HEAT PUMP** - Heat pump only.
- **H PUMP PREF.** - For when a heat pump is in combination with other heating systems and you want to use the heat pump only when it is most effective.

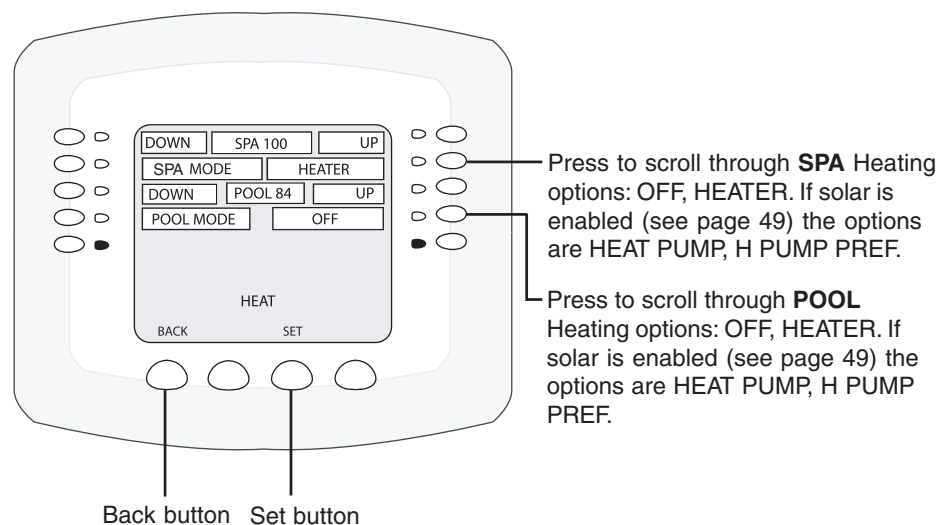

## Switching on Lights Manually

Up to 12 lights can be accessed from the **Lights** screen. You can also set up the *Color Set*, *Color Swim* and *Color Sync* special lighting features. Lights that have dimming functionality can be dimmed from the Lights screen. *SAM* or *SAL* fiber optic or Halogen lights cannot be dimmed. For more information, refer to “Setting up Lighting Options,” page 45.



To manually switch on lights, press the **LIGHTS** button on the bottom of the main screen:

1. To switch a light system on, find the label for the lighting system you want to switch on. Press the button next to the label of the light system you want to switch on.
2. If you have more than six circuits, press the **Previous 6** or **Next 6 button** to see these circuits.
3. Press the **All On** button at the bottom of the screen to switch all the lights on.
4. Press the **All Off** button at the bottom of the screen to switch off the lights when you are done.

*Note: All +3 IntelliTouch models include Color Set, and Color Swim lighting features.*

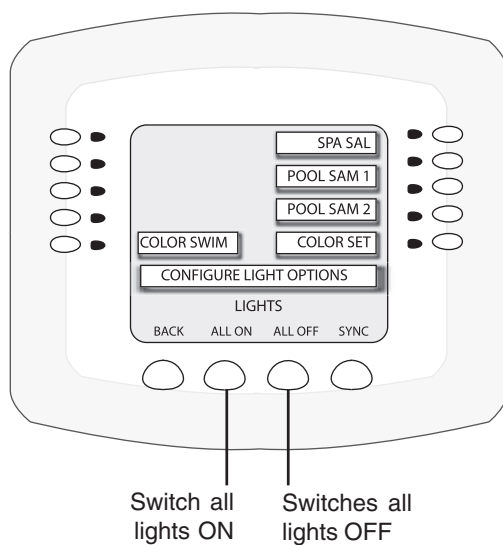

## Special Lighting Features

If you have at least two Pentair *SAM* and/or *SAL*, and/or *FIBERworks* lighting systems, you may use the special light features to change the lighting settings (only available with +3 models). Up to 12 of these lights systems can be independently controlled from the **Lights** screen.

You can change the following light features:

- **Color Set** - Allows a combination of up to 12 *SAM*, *SAL*, or *FIBERworks* lighting circuits to be preset to specific colors. This feature is not available for i5 or i5S systems. This feature requires a separate relay for each light to achieve different colored lights.
- **Color Swim** - Allows a combination of up to six *SAM*, *SAL*, or *FIBERworks* lighting circuits to be preset to transition through colors in sequence. This gives the appearance of colors dancing through the water. You can adjust the delay of each light to make the colors move at different speeds. This feature is not available for i5 or i5S systems. This feature requires a separate relay for each light to achieve the “Color Swim” lighting feature.
- **Sync** - Causes all color changing lights to synchronize their colors. This feature is available on all IntelliTouch models.

*Note: Before you start, review the lighting setup details, refer to “Setting up Lighting Options,” page 45. This procedure is usually done by the installer.*

To activate the special lighting features, press the **LIGHTS** button on the bottom of the main screen:



1. Press the button next to **Color Set** to get all lights to a pre-programmed color.
2. Press the button next to **Color Swim** to cycle the lights as though swimming through the water.
3. Press the button next to **Sync** to activate all color changing lights to synchronize.
4. To configure lights on this screen press **Configure**.

*Note: It may take up to a minute or more for Color Set, Color Swim, or Sync to function as programmed depending on what kind of light you are activating and what state it was in when the effect was activated.*

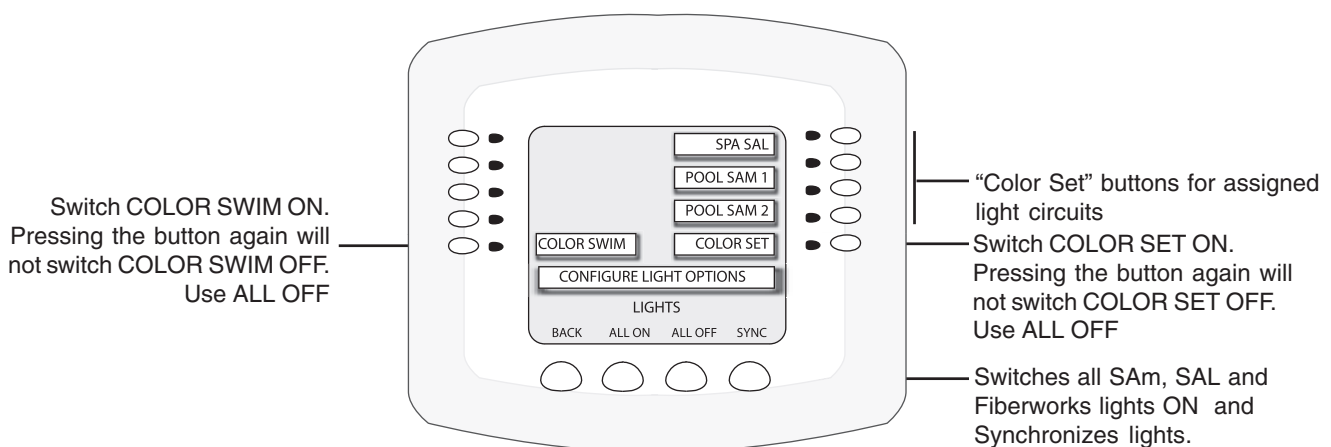

## Dim Lights

In order to dim lights, the Dimmer Module (P/N 520406) must be installed by a qualified electrician in the Load Center or Power Center. Only incandescent tungsten filament lights may be dimmed (not Halogen lights). The feature circuit must be assigned a dimmer circuit function. To assign a circuit function, see page 43.

To dim lights, go to the assigned circuit name:

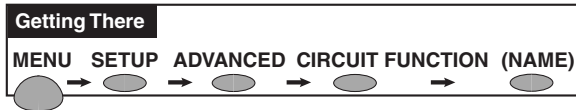

1. Press the button briefly next to the circuit name. A light should come on and be switched on at the specified dimming level.
2. To change the dimming level hold the circuit button down until the **Dimmer Level Settings** screen displays as shown below.
3. Press the button next to **Decrease** to decrease the dimming level, and the button next to **Increase** to increase the dimming level. The percent value displays the current dimming level setting.
4. Press **Save** when done. The light will adjust to the set dimming level.

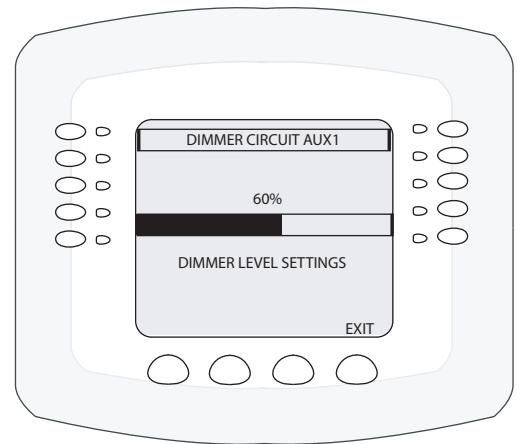

*Note: Macros can turn on light dimming circuits, but lights cannot be dimmed through the macro. The dimming level must be changed for each light dimming circuit.*

## Setting ON/OFF Times for Equipment

From the “Program” screen, you can schedule IntelliTouch to automatically run equipment like pool filtration or lights. Any circuit (auxiliary, feature, or macro) can be scheduled to switch on and off at a specific time and on a any day(s) of the week. Up to 99 total programs may be created for all circuits combined.

**Schedule a program:** The “Program” screen displays a program counter in the upper right (1/0) side of the screen. This counter indicates the current number of scheduled programs. After setting the start and stop time and the day(s) to run the first scheduled program, press **Save** to view the first program (1/1) and increment the counter to next program. To access the next program screen, press the button next to the counter label (2/1). Set the start and stop time and the day(s) to run the second scheduled program (2/1). Repeat this process to enter another program. For example, **2/3** indicates that you are viewing **program 2 of 3** total programs saved for that circuit. **4/3** indicates that you are creating program 4 but only 3 are currently saved. After pressing the Save button, the counter updates to 4/4. Press the button to the right of the label counter to step through each program first then display the unsaved program screen. The following describes how to program equipment to run the pool filtration system. This process is the same for any installed equipment listed on the screen.

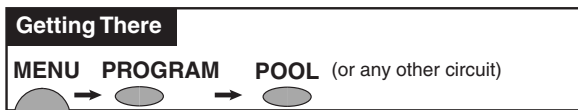

Go to the **Program/Select** equipment screen. From this screen you can select SPA, POOL or any of the AUX equipment circuits to program.

1. Press the top right button next to **POOL** to access the “Program” screen to program the pool equipment.
2. **To set the start time:** Press the second button down on the left side, next to **HOURS** (and the start flag icon) to set the hour. Press the right button to set the minutes for the start time. To use the “EGGTIMER” feature, see page 18.
3. **To set the stop time:** Press the third button down on the left side, next to **HOURS** (and the stop icon) to set the hour. Press the right button to set the minutes for the stop time. To use the “ONCE ONLY” feature, see page 17.
4. **Days:** If you want to program certain days and not run **EVERY DAY**, press the button either side of the **DAYS** label. The days of the week screen displays. The lights next to the days of the week are on. To switch off a day, press the button next to the day. The light switches is off. To set all day on, all lights should be on. Press **Save** after selecting the days of the week to run the program. The previous screen will be displayed.
5. Press **Save** to save the current program.

*Note: If a circuit is assigned a color changing light Circuit Function (SAM, SAL, etc.) an additional menu at the bottom of **Smart Start** displays. Press this button to toggle between **SS\_Yes** and **SS\_No**. If the top label displays **SS\_Yes**, the circuit will switch on and automatically begin changing colors.*

6. To create another program, press the button next to the counter label (2/1) to access the next program screen and repeat steps 1 through 4. To erase a program press the **Clear** button then **Save**.
7. Press the **Back** button to return to the **SPA, POOL** and **AUX** equipment selection screen to choose other equipment. Press the **Exit** button to return to the main screen.

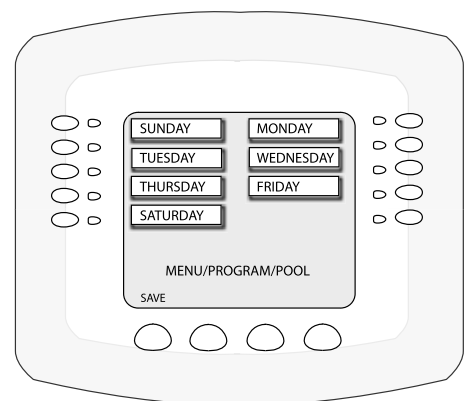
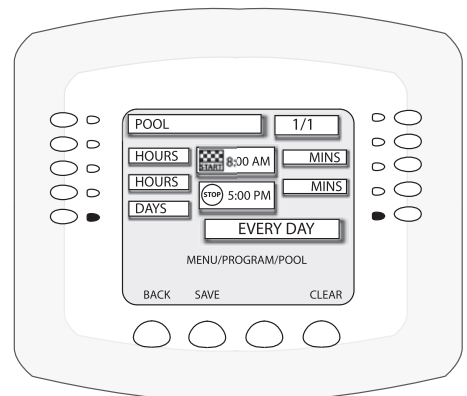



## Using the Once Only Timer

The “Once Only” feature enables you to automatically switch equipment on for one time. For example, you can set to have the spa and heater switch on before you get home from work for one evening. Unlike a regular scheduled program, the “Once Only” program does not repeat.



Go to the **Program/Select** equipment screen. From this screen you can select SPA, POOL or any of the AUX equipment circuits to program.

The following example describes how to program the spa equipment using the “Once Only” feature:

1. Press the button next to **SPA** to access the “Program/Select” screen to program the spa equipment. If this is the first program, the program counter displays (1/0).
2. Press the third button down on the left side, next to **HOURS** and select **ONCE ONLY** (Once Only is displayed one press after 11:00 PM).
3. Press the second button down on the left side next to **HOURS** to set the start time.

*Note: Press the button under CLEAR to reset the default settings.*

4. **DAYS:** The label displays **EVERYDAY** which means today only. If the time you are setting has passed for today, the “Once Only” program is set for tomorrow. If you want to program certain days and not run **EVERYDAY**, press the button either side of the **DAYS** label. The days of the week screen displays. The lights next to the days of the week are on. To switch off a day, press the button next to the day. The light switches is off. To set all day on, all lights should be on. Press **Save** after selecting the days of the week to run the program. The previous screen will be displayed.
5. Press **Save** to save the current program. The program counter displays (1/1).
6. Press the **Back** button to return to the **SPA, POOL** and **AUX** equipment selection screen to choose other equipment. Press the **Exit** button to return to the main screen.

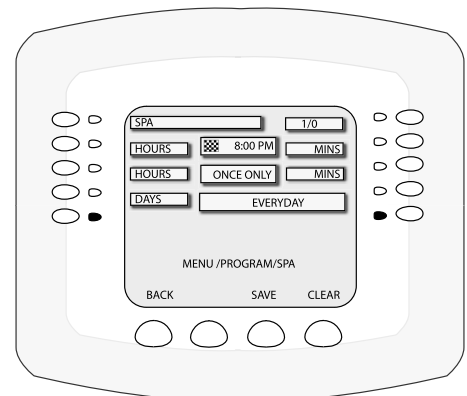
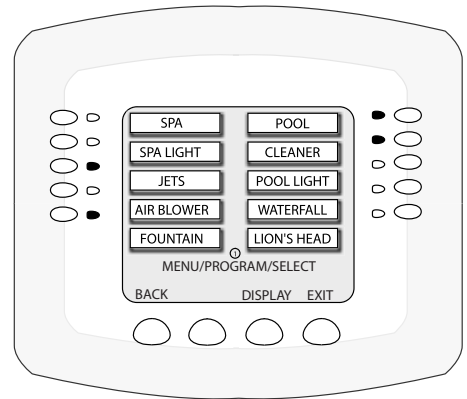

## Setting the Egg Timer Function

The “Egg Timer” feature lets you manually switch on equipment and switch off automatically after a specified time. You can set this timer feature for other equipment such as lighting, the spa, or the spa jets. Equipment can be programmed to be switched on for one minute to 24 hours. You can also use the “Don’t Stop” feature to override the 12 hour default switch off time, and run continuously until manually switched off.. If you have never set the timer for a specific piece of equipment, the factory default time is set to 12 hours.

If you have a power outage, this feature will not switch the equipment back on, you need to use set the system in “Service” mode at the Outdoor Control center to switch the equipment back on. For more information, refer to “Service Mode,” on page 74.

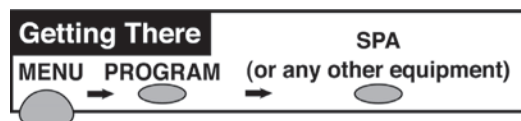

Go to the **Program/Select** equipment screen. From this screen you can select SPA, POOL or any of the AUX equipment circuits to program.

The following example describes how to program the spa equipment using the Egg Timer feature:

1. Press the button next to **SPA** to access the “Program/Select” screen to program the spa equipment. If this is the first program, the program counter displays (1/0).
2. Press the second button down on the left side, next to **HOURS** until **EGG TIMER** is displayed. (EGG TIMER is displayed one press after 11:00 PM).
3. Press the third button on the left side next to **HOURS** to set count down time in hours (from 00:00 to 23:00 hours). You can also select “**DON’T STOP**” to run the circuit continuously until switched off manually. “DON’T STOP” is displayed one press after 23:00. Press the third button down on the right side next to **MINS** to set the minutes.

*Note: Press the button under CLEAR to reset the default settings.*

4. **DAYS:** The label displays **ALWAYS** which means run the program to automatically shut-off in the specified time.
5. Press **Save** to save the current program. The program counter displays (1/1).
6. Press the **Back** button to return to the **SPA, POOL** and **AUX** equipment selection screen to choose other equipment. Press the **Exit** button to return to the main screen.

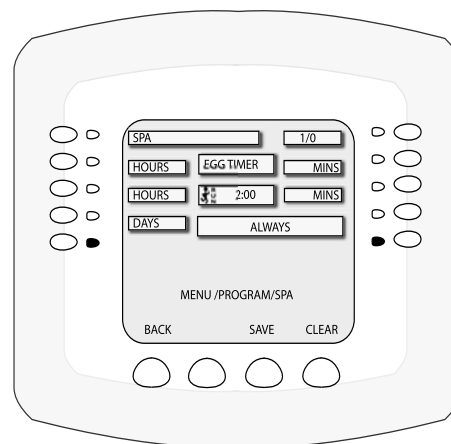
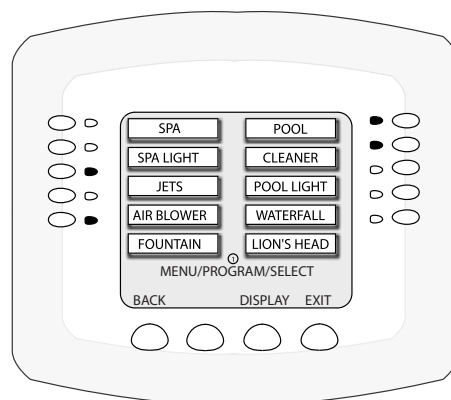

## iS10 Spa-Side Remote Controller

The iS10 Spa-Side remote controller is listed UL (1563) for use with the IntelliTouch systems at the water's edge. An iS10 controller can control up to ten functions including a spa temperature adjustment. As many as four iS10's can be installed in i7+3, i9+3, i9+3S, and i10+3D systems. Only one iS10 is supported by the i5 and i5S systems. Note, it is possible to use two iS10's on an i5 system, however, the two iS10's will mirror each other (same ID's).

Five in-line buttons control up to ten system functions numbered one through five from left to right as shown (if the system allows). A label above or below the buttons identifies each circuit function. A “peanut-shaped” middle button toggles between which row of circuit functions will be activated when one of the five in-line buttons are pressed. A red status LED above and below the toggle button indicates which row (Top or Bottom) is active. When one of the in-line buttons is pressed, an adjacent red status LED will be on light, indicating that the circuit has been activated. The default circuits activated by each button are shown in the table below. The iS10 includes an LED display shows the current spa water temperature. The spa temperature may be increased or decreased by pressing the up or down arrow button located under the display. The temperature display will blink while being changed. After setting the desired temperature, the display will return to steady and show the actual temperature as it meets the set point. The temperature set by the iS10 is only temporary. When the Spa mode is switched OFF, the temperature set at the Indoor Control Panel will resume the next time the spa mode is activated (see “Set Manual Heat for details on page 58). The Spa Mode will automatically turn off after 24 hours. For iS10 button configuration information, see page 33.

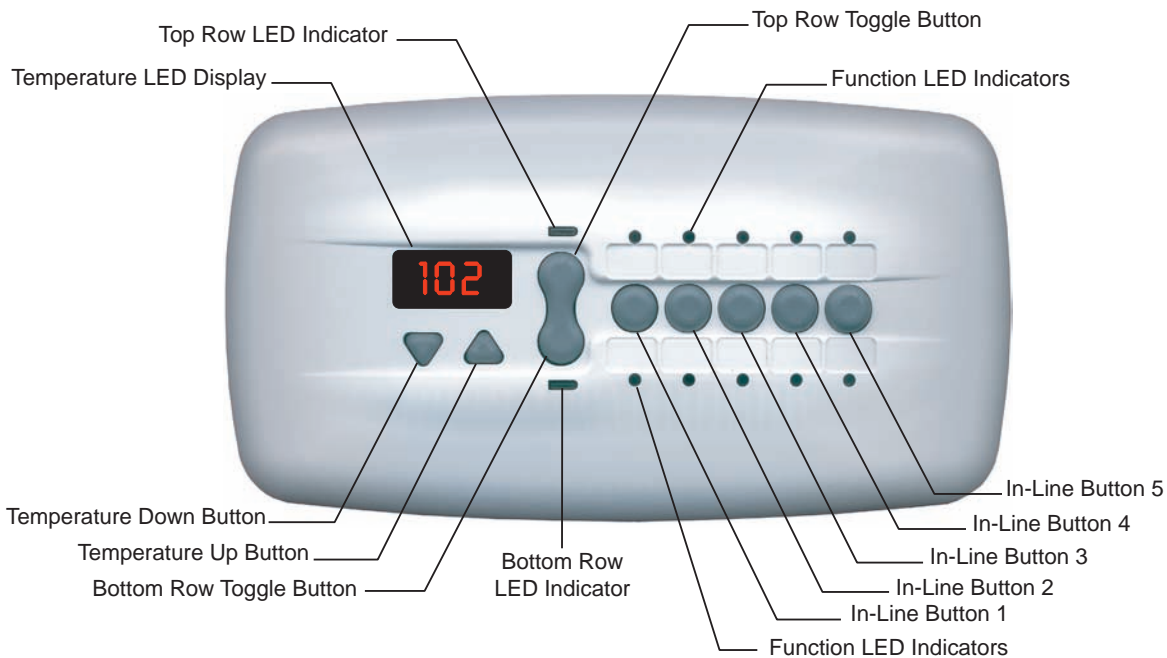

**iS10 Spa-Side Remote Controller**

| Button 1 | i5, i7+3, i9+3, -10+3D, | SPA     | POOL    |
|----------|-------------------------|---------|---------|
|          | i5S, i9+3S              | HI-TEMP | LO-TEMP |
| Button 2 |                         | AUX 1   | AUX 5   |
| Button 3 |                         | AUX 2   | AUX 6   |
| Button 4 |                         | AUX 3   | AUX 7   |
| Button 5 |                         | AUX 4   | AUX 8   |

## iS4 Spa-Side Remote Controller

The iS4 Spa-Side remote controller is a double-insulated, waterproof device that is UL (1563) listed for installation at the water's edge. It is typically installed at the tile-line of the spa wall, or in the deck within arm's reach of a spa occupant. The iS4 provides remote switching of up to four control circuits from the spa or nearby location. It is typically used for activating spa circulation and any three auxiliary pieces of equipment (such as lights, jet pump, air blower, etc.). The red status light glows steady when in Spa mode and flashes while spa is heating. For iS4 button assignment information, see page 58.

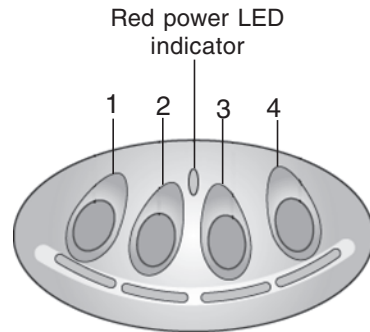

iS4 Spa-Side Remote Controller (Wall or tile mount)

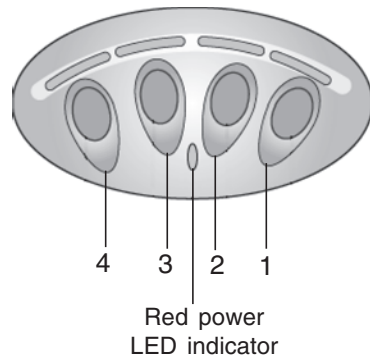

iS4 Spa-Side Remote Controller (Deck mount)

## MobileTouch Wireless Controller

With an operating range of up to 300 ft, the MobileTouch wireless controller provides the same functionality as the IntelliTouch Indoor Control Panel. The optimum wireless transmit and receive range may be effected by physical obstructions, (especially those containing metal), weather conditions, and geographical features.

**WARNING!** Do not plug in the AC adapter to a power source within five (5) feet of the pool and spa. Canadian installations require a minimum of (3) meters from pool water. Do not recharge outdoors.

**CAUTION!** The MobileTouch controller screen is an LCD (liquid crystal display) which can be sensitive to sunlight. When exposed for extended periods the LCD screen will heat up and go black. If this happens, place the remote in a shaded area and allow the screen to cool down. Do not attempt to adjust the contrast or the screen will be unreadable when it eventually cools. When used outside, keep the remote covered or in a shaded area. Prolonged exposure to sunlight may permanently damage the unit.

**CAUTION!** The MobileTouch wireless controller is only water resistant and can be exposed to temporary splashing or wet hands. However, the controller is NOT intended to be submersible. Remove unit immediately if it is dropped in the water or exposed to rain. Store the unit indoors in a dry environment. Do not charge the remote when it is wet.

**CAUTION!** Only use Pentair approved AC adapter transformer.

*Note: For details about enabling the MobileTouch wireless controller, refer to “Enabling the MobileTouch Wireless Controller,” page 31.*



MobileTouch Wireless Controller

## Charging the MobileTouch Wireless Controller

To charge the MobileTouch controller battery:

- Plug the AC adapter (provided with the Personality Kit) into an AC wall outlet. Insert the AC Adapter plug into the MobileTouch power jack.

*Note: A full day's usage requires a complete battery charge (4-5 hours). With a charge time of 10-15 minutes on a dead battery, usage may be up to an hour. The battery is NOT field replaceable. Return unit to the manufacturer for factory service.*

## Using the MobileTouch Wireless Controller

The range of the MobileTouch wireless controller can be up to 300 feet from its transceiver antenna. The antenna is typically located near the IntelliTouch Load Center. The unit can be used all day at full power with a complete battery charge (4-5 hours). With a charge time of 10-15 minutes on a dead battery, usage may be up to an hour.

To use the MobileTouch wireless controller:

1. The MobileTouch controller can be used while connected to the to the AC adapter or disconnected from the AC adapter power plug.
2. Press the button at the top of unit to switch the unit ON or OFF. The LCD backlight is set to switch off in five minutes by default. If you wish to change this setting, see “Preference Screen Options,” on page 37.
3. The MobileTouch controller is ready for use.

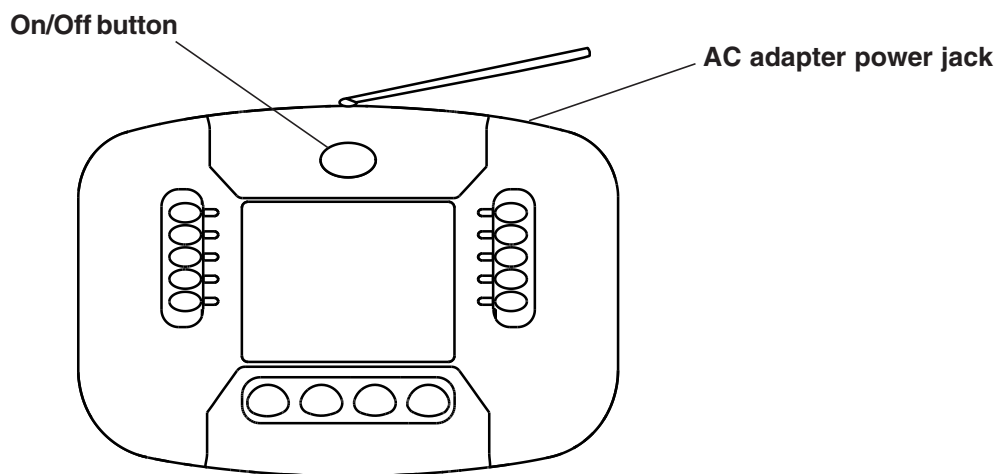

MobileTouch Wireless Controller

## QuickTouch Wireless QT4 Remote Controller

The QuickTouch QT4 wireless remote controller provides switching of up to four circuits. It is typically used for activating the spa circulation, and for operating three auxiliary pieces of equipment (such as lights, jet pump, air blower, waterfall, etc.).

Each of the four functions on the QT4 remote controller has an ON and an OFF button. To switch a circuit on or off, press and hold the appropriate button for at least a full second.

Although the Remote is capable of duplicating any four circuits, it has been preset at the factory to control the following:

- Spa button activates the spa circuit.
- **A** button activates **Auxiliary 1** circuit.
- **B** button activates **Auxiliary 2** circuit.
- **C** button activates **Auxiliary 3** circuit.

***Note:** To control circuits other than Spa, Aux1, Aux2 and Aux3, it is possible to make adjustments through the Indoor Control Panel or MobileTouch wireless control panel.*

***IMPORTANT:** The QT4 remote may be used with wet hands, but should never be submersed in water, as this could damage the unit. If accidental submersion occurs, dry unit out by removing battery cover and removing battery. Position unit so that water can drain out. Reassemble when the unit is completely dry.*



QuickTouch QT4 Wireless Remote Controller

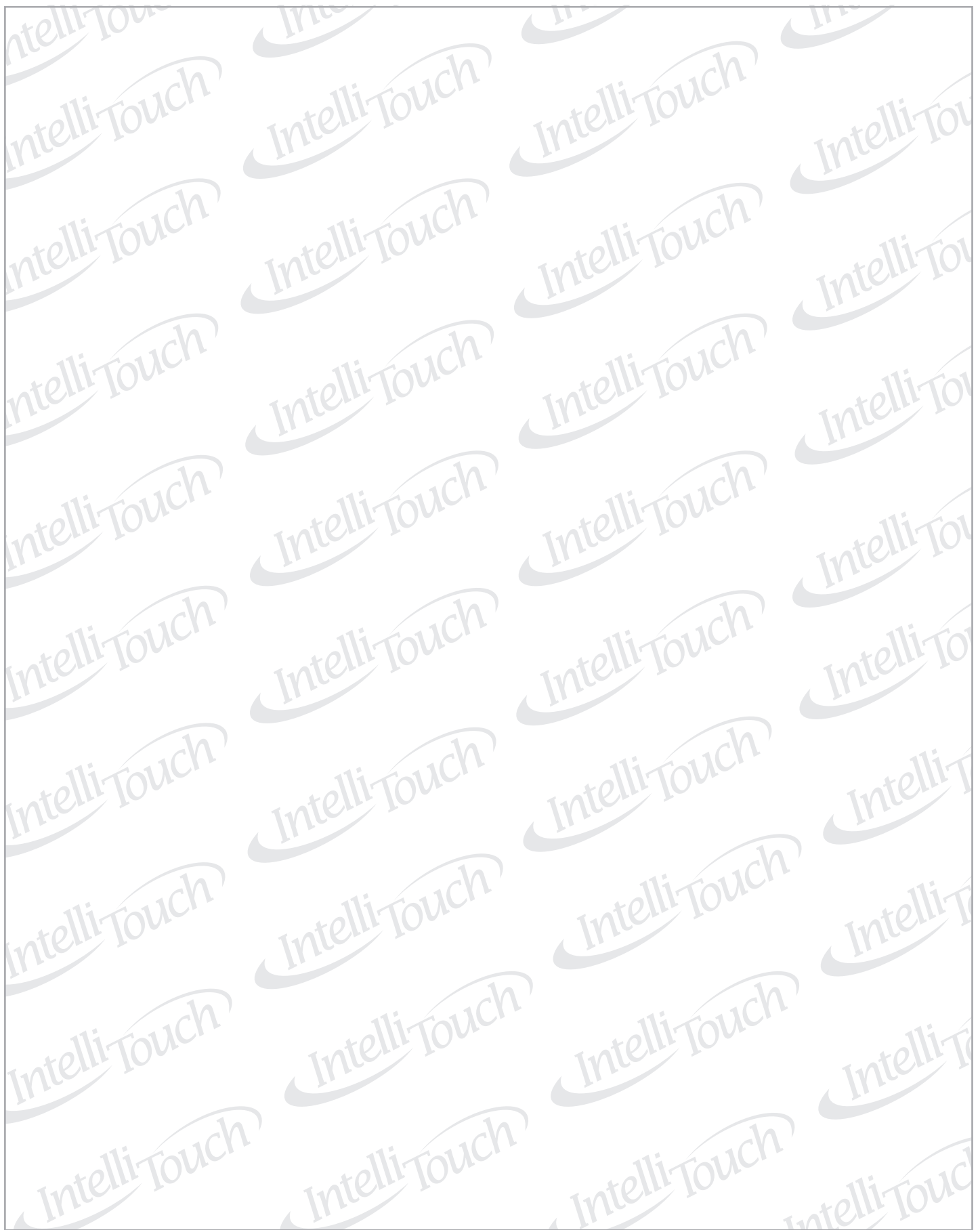





## **Preparing the System for Initial Start-Up**

## Setting up the IntelliTouch System

Use the following recommended steps to configure the IntelliTouch system using the Indoor Control Panel or MobileTouch controller.

### 1. Main screen settings (pages 37 - 38)

Set time, date, clock, button beep sound levels, lights and screen brightness levels.

### 2. Assign circuit names (pages 40)

Assign circuit names for output auxiliary equipment.

### 3. Creating custom names for auxiliary circuits (page 42)

There are nearly 100 circuit names stored in the IntelliTouch software (see page 23 for the complete list). If you cannot find one to fit your application you can create up to 20 custom names.

### 4. Assign a circuit function to a circuit name (Page 43 )

From your worksheet **Programmable Settings** section, assign circuit functions to all circuits that are not marked **GENERIC**. Nothing needs to be done if the circuit is **GENERIC** (simple ON/OFF when the button is pushed). From the **Circuit Functions** screen, you can also assign special logic to a circuit by selecting one of the circuit functions. The circuit functions are: Master Cleaner, Light, Dimmer, SAM Light, SAL Light, Photon Generator, Spillway, and Color Wheel. Check page 25 for all names

### 5. Create and assign a feature circuit name (pages 56)

Based on the temporary circuit names from the worksheet (page 61), create and assign circuit names to the auxiliary (AUX) connections. On the **Assign Circuit Screen**, auxiliary circuit names are assigned through **Displays 1 through 4**. Displays 1 through 4 correspond to the main Load Center or Power Center (Display 1) to which they are wired. Display 2 through 4 may be additional Expansion Centers. Note the original names presented, **AUX 1** through **AUX 10**, correspond to the plug-in location of the relay on the Outdoor Control Panel in the main Load Center or Power Center. Feature circuits are assigned on the **Feature Circuit** screen. Select from the available list circuit names. For a complete list of circuit names see page 41. Up to 20 additional names may be custom created prior to assigning names, see page 42. If the circuit is to be a **Macro**, then refer to page 57.

### 6. Configure valve actuators controlled by AUX or feature circuit (page 48)

Assign which circuits will activate which valves (A and B or optional C, D, E). If more than one circuit must operate the same valve, then one Feature Circuit may be created and configured to activate the valve. Then create Feature Circuits for all other circuits and use the Macro function to activate the valve along with any relay connections. Feature circuits are not available for i5 or i5S systems.

## 7. Setting up additional equipment (pages 48)

Tell the system what special equipment the system may have.

- Is solar heating available? Is solar being used for a heat pump?
- What circuits will turn 2-Speed pumps to High Speed?
- Cool-down cycle for the heater - Lets you set circuits that switch the filter pump to high speed.
- Do you want to delay turning off the filter pump for 10 minutes when the heater is turned off?
- Do you want the spa to heat whenever the Spa button is pressed?

## 8. Set up Solar Equipment, 2-speed pump, Set a heater cool-down cycle (pages 49)

Set up additional equipment if required. Set up the chlorine generator

Set up the Indoor Control Panel to operate with optional salt chlorine generators.

## 9. Configuring the heater system options (pages 12)

Set times for automatic circuit activation. Each system may have up to 99 total programs. All user created programs are active all the time; so check that there are not conflicting automated times.

## 10. Create Macros from Feature Circuits (pages 57)

Now that all the simple circuits are defined, you may combine circuits (Auxiliaries and Features) to maximize the system capability. Feature circuits that are assigned as **Macros** may also have all the same Circuit Functions and Equipment capabilities as any other circuit. Simply repeat the above steps using the Feature Circuit name.

## 11. Configure spa-side remote (iS4, iS10, QT4) buttons (pages 58)

Set which circuits will be operated by which button on each remote. Once you have checked all buttons operate properly, place labels on remote controls.

## 12. Set the delay cancel feature (page 51)

Set the one time Delay Cancel feature for the heater, 2-speed pump, and automatic pool cleaner.

## 13. Set on/off times for circuit (pages 16-18)

Set times for automatic circuit activation. Each system may have up to 99 total programs. All user created programs are active all the time; so check that there are not conflicting automated times.

## 14. Configure the lighting options screen (page 45)

From this unique lighting screen you can enable special control of your pool and yard lighting, such as color changing lights, and synchronized colored lights.

## Automatically Enabled Wired Controllers

When powered up for the first time, the IntelliTouch system will automatically enable one each of the following wired controllers:

- Outdoor Control Panel (located in the main Load Center or Power Center)
- Indoor Control Panel (wired to the Personality board in Load Center)
- iS10 Spa-Side Remote (wired to the Personality board in Load Center)
- Expansion Center (includes Outdoor Control Panel model i5x or i10x)

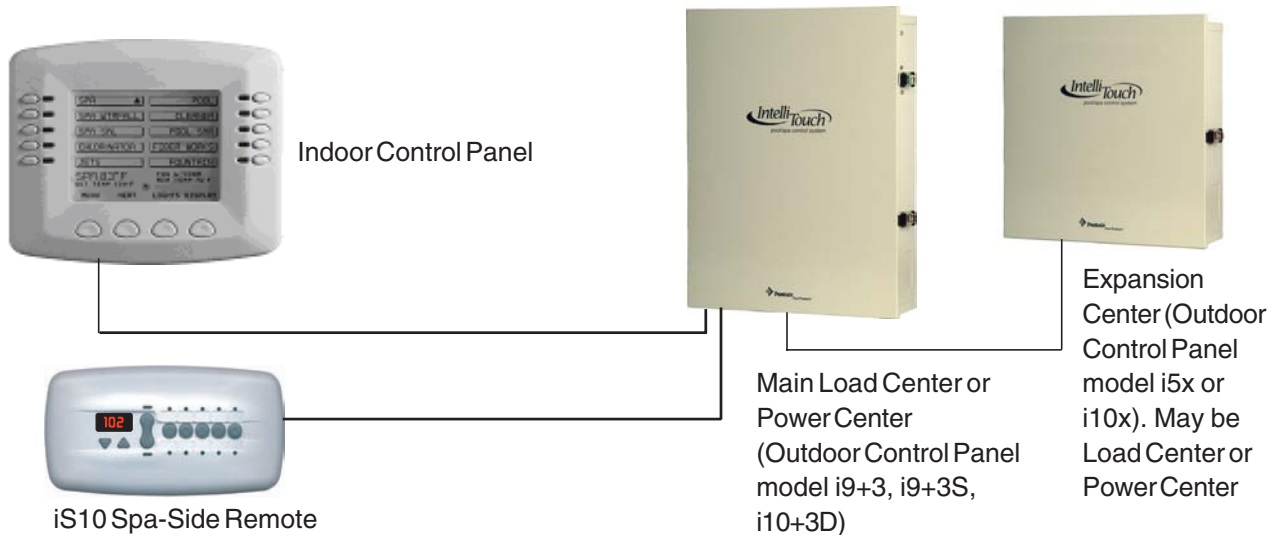

**IntelliTouch System Controllers (automatically enabled)**

## Adding Multiple Controllers and Expansion Centers

When adding multiple Indoor Control Panels, iS10 Spa-Side controllers, and Expansion Centers, you will need to manually enable each controller and assign an Expansion Center. The IntelliTouch system will then be configured to use the additional controller and Expansion Center. To manually enable a wired controller, refer to “Manually Enabling Wired Controllers and Remotes,” on page 29. To assign multiple expansion centers, refer to “Assigning Additional Expansion Centers” on page 30.

## Adding a MobileTouch Wireless Controller

Before using a MobileTouch wireless controller with the IntelliTouch system, it must first be manually enabled. For details, refer to “Enabling a MobileTouch Wireless Controller,” page 31.

## Testing the Indoor Control Panel and MobileTouch Controller

To test communication to the Outdoor Control Panel for either the Indoor Control Panel or MobileTouch:

- Press the button next to Spa or Hi-Temp (upper left, depending on the model of Indoor Control Panel). A green light will be on. If none of the lights are on, refer to System Problem Diagnosis,” page 79, in the Troubleshooting section.

## Manually Enabling Wired Controllers and Remotes

To manually enable additional wired controllers, remotes (Indoor Control Panel, iS10 Spa-Side remote Controller) and Expansion Centers, perform the following steps on the Outdoor Control Panel located in the main Load Center or Power Center and at the controller(s) and additional Expansion Centers.

**Note:** For information about how the IntelliTouch automatically enables wired controllers, refer to the “Automatically Enabled Wired Controllers,” page 28.

To manually enable additional wired controllers and Expansion Centers:

1. On the Outdoor Control Panel, press the **Reset** button.
2. The three red **System Control** LEDs will be on for about 10 seconds. While these LEDs are lit, press auxiliary **Button 1**.
3. The **auxiliary LEDs** begin flashing together. The system is ready to enable the additional wired controllers (Indoor Control Panels, iS10 Spa-Side remote controllers, and Expansion Centers).
4. **ENABLE EACH CONTROLLER OR REMOTE:** For instructions about enabling each controller, remote and Expansion Center, refer to the following:
  - Indoor Control Panel, go to page 66
  - iS10 Spa-Side Remote, go to page 33
  - Expansion Center, go to page 30
5. After each controller is enabled, press **Reset** on the Outdoor Control Panel and wait until the red Auto and Pool LEDs are lit. The system is ready for normal operation.

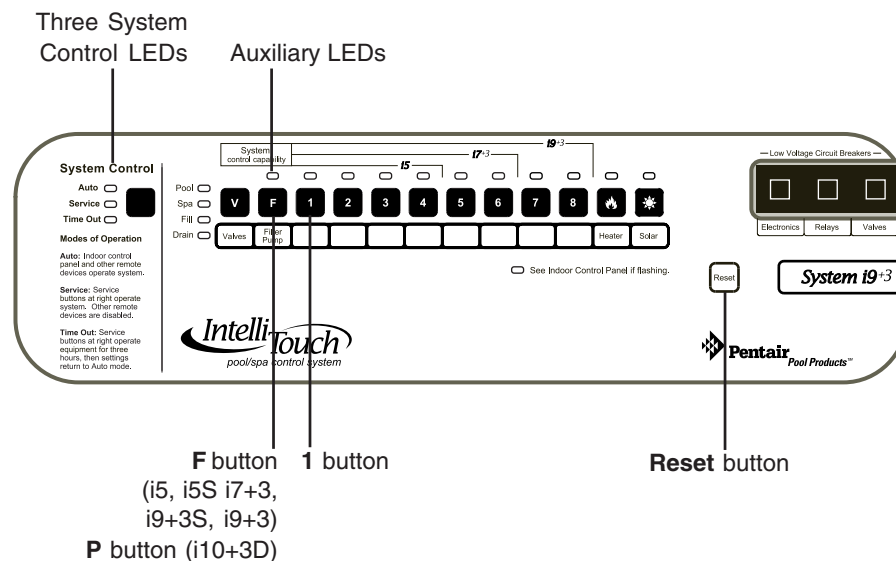

Main Outdoor Control Panel (Located in the Load Center or Power Center)

## Assigning Additional Expansion Centers

Up to three additional Expansion Centers can be used in an IntelliTouch system. The IntelliTouch system automatically assigns the “main” Load Center or Power Center as number 1, and other additional Expansion Centers as number 2, 3, or 4. An Expansion Center includes an Outdoor Control Panel (model i5x or i10x) which is connected to the Load Center or Power Center.

**Note:** If the first Expansion Center was installed with the main Load Center or Power Center, it will automatically be assigned as number 2. Other additional Expansion Centers need to be manually assigned a number.

To manually assign a number for an Expansion Center:

1. On the Expansion Center, press the **Reset** button and wait for two seconds, and press **Button 1**. The System Control LEDs on the Expansion Center will flash.
2. **Buttons 2, 3, and 4 LEDs** will be on. Do one of the following:
  - If this is the first Expansion Center, press **Button 2**.
  - If this is the second Expansion Center, press **Button 3**.
  - If this is the third Expansion Center, press **Button 4**.

**Note:** Do not set more than one Expansion Center to the same number. These numbers correspond with the numbered display screens on the Indoor Control Panel and MobileTouch wireless controller.

3. The red LED will be on above the selected button number.
4. Repeat the steps above for each additional Expansion Center.

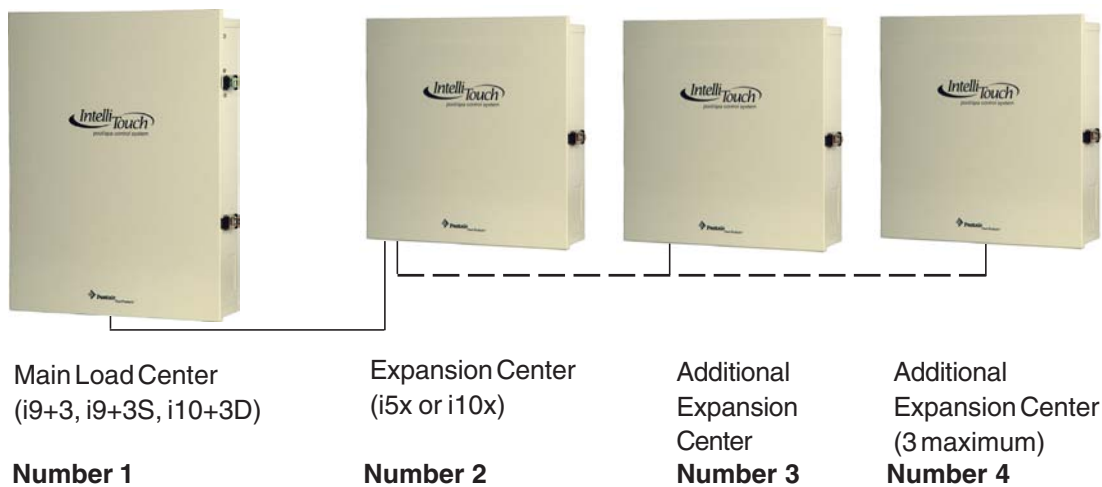

**Note:** Expansion Centers may be a Load Center or Power Center.

## Enabling a MobileTouch Wireless Controller

When adding a MobileTouch wireless controller to a new or existing IntelliTouch system installation, you must first manually enable it before using it with the IntelliTouch system.

To manually enable the MobileTouch wireless controller:

1. On the Outdoor Control Panel, press the **Reset** button.
2. The three red **System Control** LEDs will be on for about 10 seconds. While the LEDs are on, press the **“F” Filter** button. For model i10+3 press the **“P” Pool Filter Pump** button. For model i5S, press the **1 button**.
3. The auxiliary **LEDs** will cycle through the V (or F) button and the 1, 2, 3, 4 buttons. The system is ready to enable the MobileTouch wireless controller.

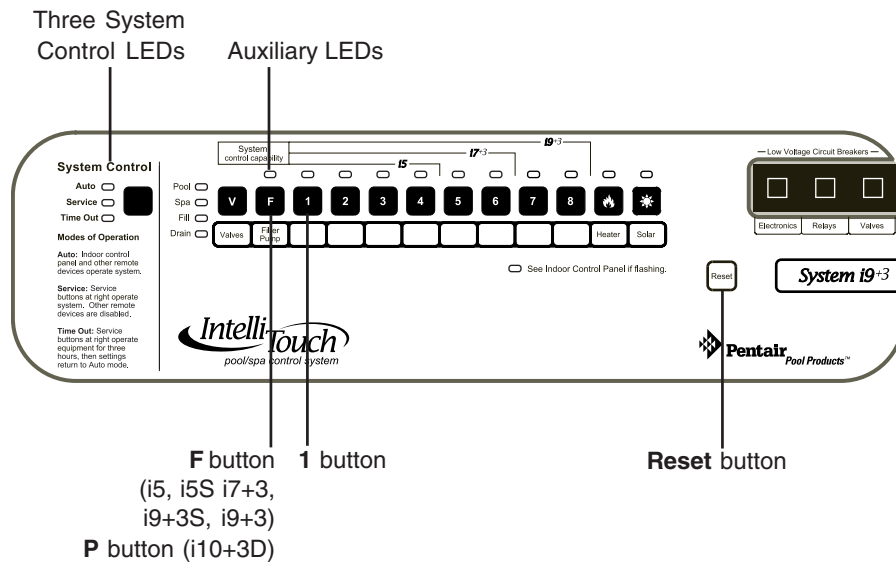

Go to the Advanced screen.



4. From the MobileTouch Advanced screen, press **buttons 2 and 4 at the same time**. The Service Personnel screen is displayed.

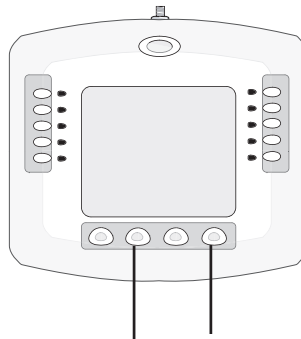

Press button 2 and 4 at the same time to access the Service Personnel screen

## Enabling the MobileTouch Wireless Controller (Continued)

5. Press the button next to **Lock On Address**. This will setup the MobileTouch controller to operate on a unique frequency to avoid inference from other wireless devices within range of the controller's Transceiver.
6. Select the control panel number (1, 2, ,3 or 4) for the controller at hand by pressing either button next to the panel number. Do not select a number already in use by another controller. Any combination of up to four Indoor Control Panels and/or MobileTouch control panels may be configured.
7. You will automatically be returned to the Service Personnel screen. Press **Exit** to return to the main screen.
8. Repeat these steps for each controller if necessary.
9. Return the Load Center or Power Center. The System Control LEDs will be flashing. Press the **Reset** button. When the "Auto" LED is on the process is complete and the system is ready for operation.

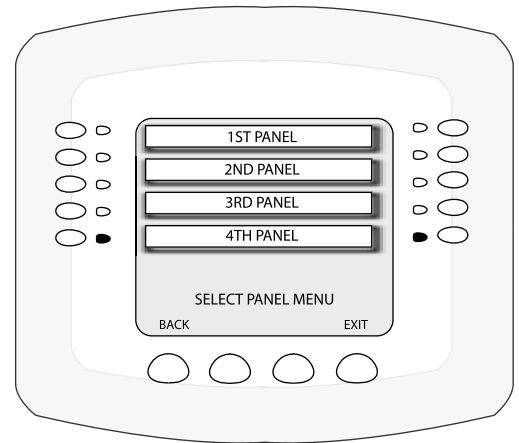
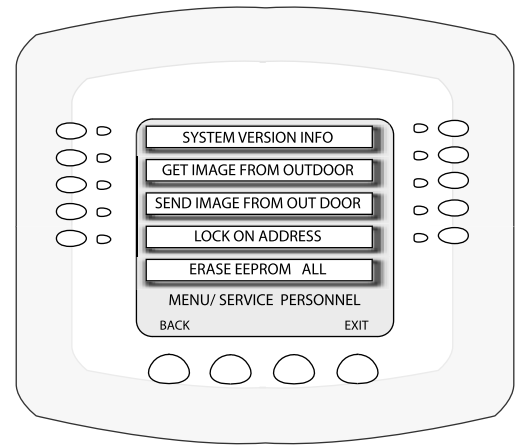



## Adding an iS10 Spa-Side Remote Controller

Up to four iS10 Spa-Side remote controllers can be installed to allow each iS10 to operate different functions or to the same functions at different locations. Each iS10 can be assigned as number 1, 2, 3, or 4. If a different number is not assigned to each installed iS10, then all iS10's are assigned as number iS1. This is useful if you wish to have the same functions available at different iS10 locations.

The following steps describes how to manually assign each iS10 a number 2, 3, or 4 as required.

**Note:** If the first iS10 was installed with the main Load Center or Power Center, it will automatically be assigned as number 1. Other additional iS10s need to be manually assigned.

To configure an additional iS10:

1. On the iS10, press the bottom part of the “peanut shaped” toggle switch and the **1** button at the same time while the Outdoor Control Panel lights are flashing.
2. The temperature display should read **SHA**.
3. The four red LEDs adjacent to the in-line buttons will be on. Do one of the following:
  - If this is the second iS10, press **2**. The temperature display reads **IS2**.
  - If this is the third iS10, press **3**. The temperature display reads **IS3**.
  - If this is the fourth iS10, press **4**. The temperature display reads **IS4**.
4. The iS10 Spa-Side Remote red LEDs will start to flash for about a minute. Wait until they stop flashing before resuming normal operation.

**Note:** To configure the buttons on the iS10 and QuickTouch (QT4) remote controller, refer to “Configuring Remote Control Button Circuits (iS4, iS10, QT4 QuickTouch, and Phone Remote)” on page 58. To disable or enable the iS10 Spa-Side Remote from the Indoor control Panel, refer to “Disable/Enable Spa-Side Remote,” page 60.

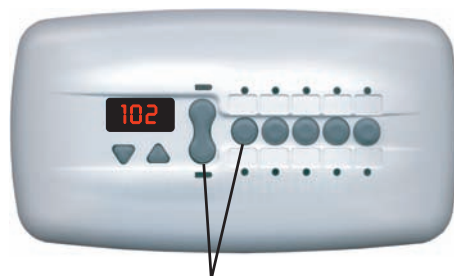
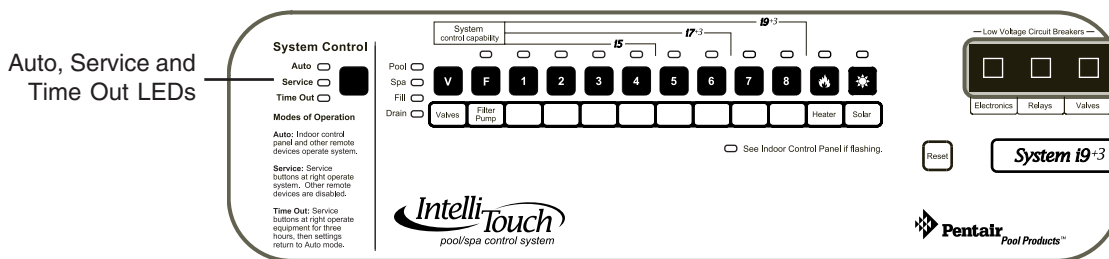

Press **Toggle switch** and **1** Button as the same time

Main Outdoor Control Panel and iS10 Spa-Side remote controller

## Prepare the System for Operation

*Note: If the system needs to be reset to the factory defaults, see “Erasing the System Memory,” on page 65.*

If you have more than one Indoor Control Panel, you only need to configure just the one main panel. Other Indoor Control Panels will be configured with the same settings and use the configured settings. Use the following steps to ensure that the IntelliTouch system is properly set up and working correctly. Before you start, make sure you have:

- Pen and paper
- Marker to label the circuits. Use the provided Circuit ID label worksheet (see page 68-73), a permanent marker, or other permanent means of labeling.
- If you are setting up a large system that covers a large area, ask your assistant to visually inspect the equipment while you test the circuits from the Outdoor Control Panel.

## Check the Main Load Center

1. Switch on the electrical power at the house breaker.
2. Switch on the Load Center or Power Center. You may need to switch on the breakers on the Load Center.
3. Wait for the following:
  - The red **Auto** LED on.
  - The light labeled **See Indoor Control Panel if Flashing** to stop flashing.

4. Press the **Service** button to put the Load Center or Power Center in Service Mode for testing.

**Note:** If you are working with the **i5**, **i7+3**, or **i9+3** systems, go to step 5. If you are working with the **i5S**, **i9+3S**, or **i10+3D** systems, skip step 5 and go to step 6. The IntelliTouch system model ID is located on the front of the Indoor Control Panel below the low voltage circuit breakers.

5. Press the **Valves** button. Step through all four valve positions: Pool, Spa, Fill, Drain. Make sure the valves rotate to the correct position and the water is moving in the correct direction for each position. If necessary, flip the actuator toggle switch to change the direction of the water. After setting the valves and the system is in “Auto” mode, do not change the toggle switches.
6. Press the **Filter Pump** button. Make sure the filter pump turns on correctly. If the pump has two speeds: Press the one time to run the pump in low speed. Press the button again to run the pump in high speed. Press the button again to switch the pump off. A Two-Speed pump has to be configured from the EQUIPMENT screen.
7. Step through the rest of the system AUX buttons. Notice which button turns on which equipment. You may need to walk the property to find what each button turns on.

8. Press each AUX button to switch on each circuit. Affix a label under the appropriate button identifying the function and number of the circuit.
9. Repeat steps 4 through 9 for each Expansion Center. Note that **Aux 1** through **Aux 10** are used as circuit names on the Expansion Centers. Do not duplicate these circuit names with the circuit names of the main Load Center or Power Center.
10. The system is automatically configured if there is no more than one Load Center, one Expansion Center, an Indoor Control Panel, and one Spa-Side Remote. If there are additional Expansion Centers and/or controllers, then these need to be configured. For details about adding multiple Expansion Centers and controllers, see “Enable Additional Expansion Centers” on page 30.

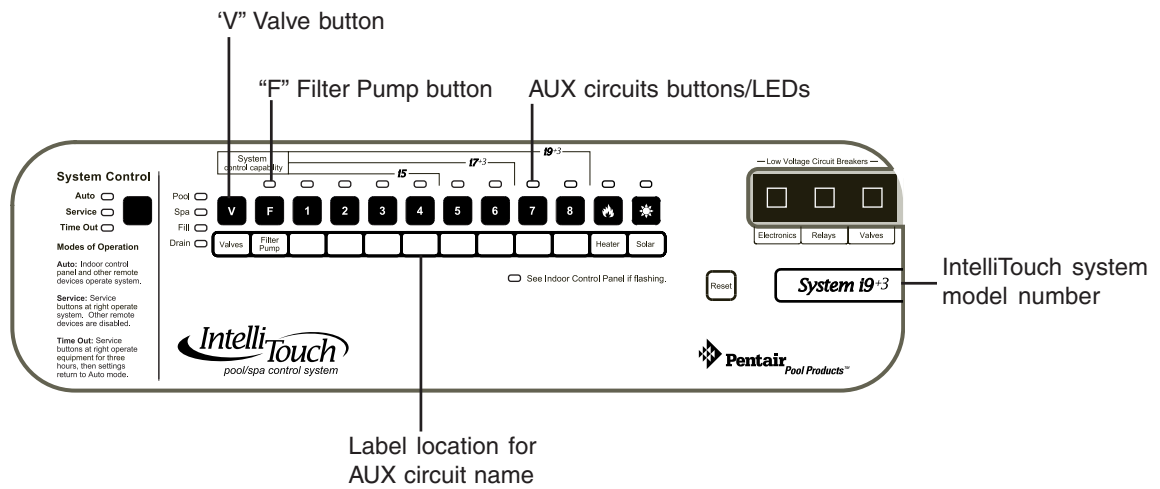

## Checking the Indoor Control Panel or MobileTouch

To test communication to the Outdoor Control Panel for either the Indoor Control Panel or MobileTouch:

- Press the button next to Spa or Hi-Temp (upper left, depending on the model of Indoor Control Panel). A green light will be on. If none of the lights are on, refer to "System Problem Diagnosis," page 79, in the Troubleshooting section.

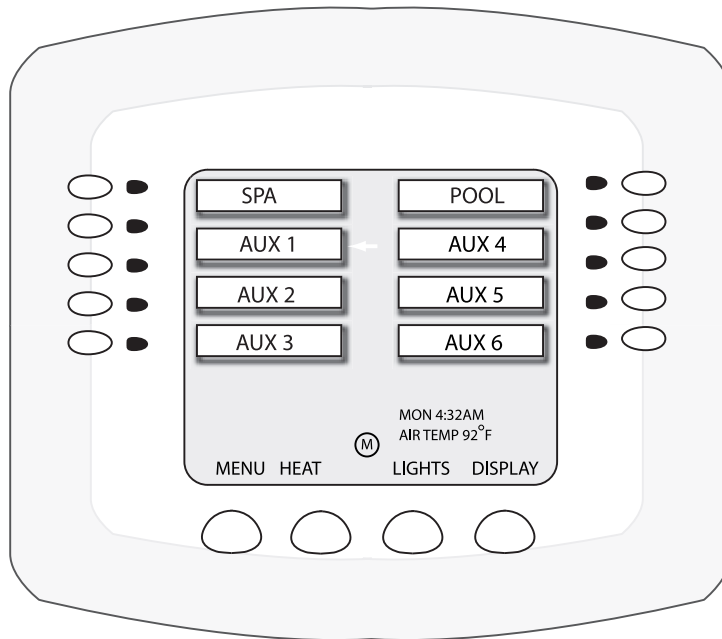

# Setting up the IntelliTouch System using the Indoor Control Panel or MobileTouch

This section describes how to configure and set up the IntelliTouch system via the Indoor Control Panel or MobileTouch.

## The Preference Screen Options

From the Preference screen you can change the control panel beeper volume, display settings, and set the



screen contrast.

To change the screen settings go to the **Preferences** screen.

1. **To change the display backlight:** Press the top left or right button and select the option that you want. The options are; **OFF IN 5 MIN**, **BLANK IN 5 MIN**, and **ALWAYS ON**.
2. **To change the display contrast:** Press either the left or right second button down, next to the **Up** or **Down** to set the contrast level.
3. **To change the brightness of the LED lights:** Press either the left or right third button down, next to **LED Brightness** label to set brightness level to set the brightness level. The LED brightness levels are **100%**, **75%**, **50%**, and **25%**.
4. **To change the display backlight brightness:** Press either the left or right fourth button down, next to **Backlight Brightness** label to set the backlight brightness. The backlight brightness levels are **100%**, **75%**, **50%**, and **25%**.
5. **To turn the button beeper sound off:** Press the button next to the **User Interface** label. In the next screen, press the button next to **Beeper Level** to **OFF**. To switch **ON** the sound, select **HIGH**. Press the **Back** button when finished.

*Note: It is recommended to leave the Key Repeat Delay and Rate set to the factory default setting (1/2 and 15 PS). The Key Repeat Delay adjusts the amount of time a key/button has to be held down before it starts auto-repeating. Key Repeat Rate adjusts the number of times per second (5, 10, 15, or 20 key repeats per second) the key/button repeats once it is held down.*

6. When finished, to save the settings press the **Exit** button to return to the main screen.

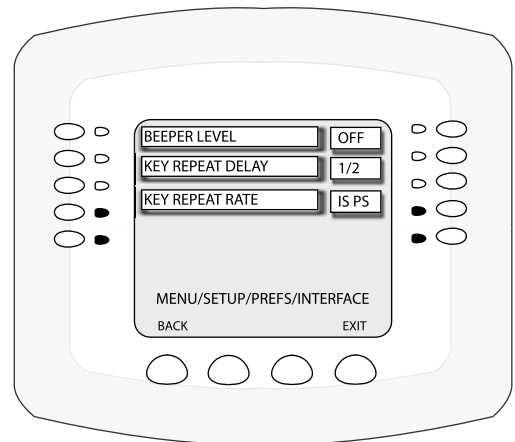
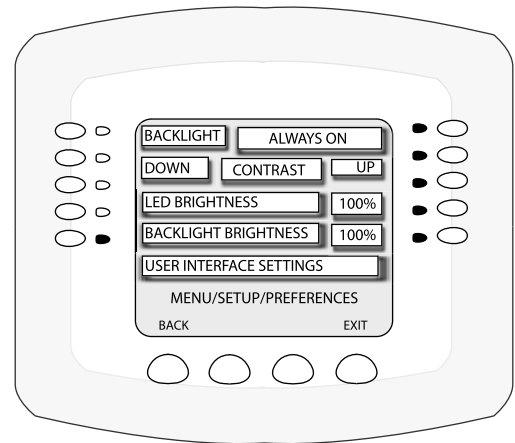

## Set the System Clock

Setting the system clock allows all automatic pool functions to work correctly. Set the clock to the current time and date for your area.

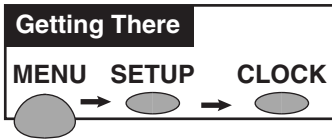

To set the system clock, go to the **Clock** screen.

1. Use the buttons on either side of the panel to set the time and date.
2. Specify the **Daylight Savings** setting.  
If you are in an area that observes Daylight Savings, set this to **Auto**. If you are in an area that does not observe Daylight Savings, set this to **Manual**.
3. Change the clock accuracy offset by seconds, press the right-side button to increase the offset and the left-side button to decrease. The offset value can be set from -300 to +300 seconds.
4. Press the **Save** button when finished.
5. Press the **Exit** button to return to the main screen.

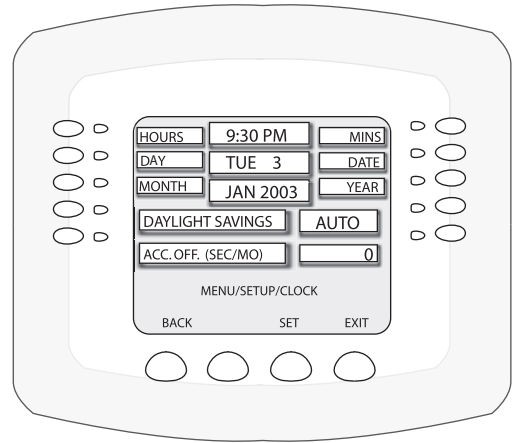

## Assigning Circuit Names to Display 1 (or Display 2, 3, and 4)

Setting the circuit names allows you to identify equipment from the Indoor Control Panel or MobileTouch wireless control panel. Many common equipment names are already programmed into the control panel.

You can also set up to 20 custom names for equipment, if one of the almost 100 programmed names does not fit. Customizing names can help the homeowner find unusual equipment they may have. For more information, refer to “Creating Custom Circuit Names for Auxiliary Circuits,” page 42.

You can also program multiple circuits to work with one button on the Indoor Control Panel and assign it a custom name. This is called creating a MACRO. For example, by creating a macro, you can program one button to switch on the spa, spa lights, fountain, and back yard lights. This is a two step process: first you create a custom name and then create the macro that program the functions to work together. Macros are stored in the Feature Circuits, where motorized valves, 2-Speed filter pump, and other features are saved. You can have up to 10 feature circuits. **Note:** This feature is not available with the i5 or i5S systems.

***Note:** The default top row of two circuits on **Display 1** always has special reserved functionality that cannot be changed. The default circuits may be given any name but always perform in the same manner. Be careful not to duplicate circuit names with these circuits. These circuits may also be used to activate 2-speed pumps to high speed, turn additional valves, etc. The preset functionality is as follows:*

### About DISPLAY Screen 1, 2, 3, 4

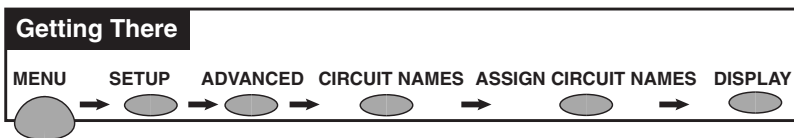

The auxiliary circuits that control the pool and spa equipment can be accessed from the Indoor Control Panel Displays screen. Pressing Display 1, 2, 3, or 4 will put you in the screen with circuits belonging to that particular Load Center or Expansion Center. The **Feature Display** assigns Feature Circuits. The Displays screens are as follows:

**Display 1** - This screen shows the filter pump, pool and spa modes, and all high voltage auxiliary circuits connected to the Load Center or Power Center.

**Display 2** - This screen shows additional auxiliary circuits connected to the first Expansion Center.

**Display 3** - This screen shows additional auxiliary circuits connected to the second Expansion Center.

**Display 4** - This screen shows additional auxiliary circuits connected to the third Expansion Center.

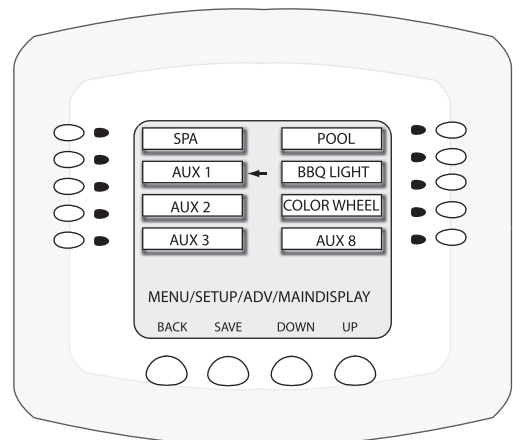

## Assigning Circuit Names

Assigning the circuit names allows you to use the pool equipment from the Indoor Control Panel. Many common equipment names are already programmed into the Indoor Control Panel.

### Labeling Circuit Buttons in the Load Center

In order to identify the equipment connected to the auxiliary circuits (SPA, AUX 1, AUX 2) in the Load Center, you need to assign names to the corresponding auxiliary circuits in the Indoor Control Panel. Many common equipment names are already programmed into the Indoor Control Panel.

Use the written list of circuit names (button 1, button 2 etc.) you made while setting up the Load Center. Find what you labeled circuit button 1, button 2 etc. The circuit names you assign must match the labels you put on the Load Center.

1. On the Assign Circuit Display screen, press the button next to the label **AUX 1**. A small arrow pointing to the name is displayed.
2. Get the written list of circuit names you made while setting up the Load Center. Find what you labeled AUX circuit button 1. The circuit names you assign must match the labels you put on the Load Center.
3. Use the **Up** and **Down** buttons at the bottom of the screen to scroll through the alphabetical list of programmed names.
4. When you find the name you want, press the button next to the label **AUX 2**. The small arrow moves to that label. You are done setting the first circuit name and are ready to program the next circuit.
5. Continue the process to assign the other circuits. Depending on the model you are programming, you may not have equipment for all circuits.
6. When you are done assigning names, press the **Save** button.
7. Press the **Exit** button to return to the Main screen.

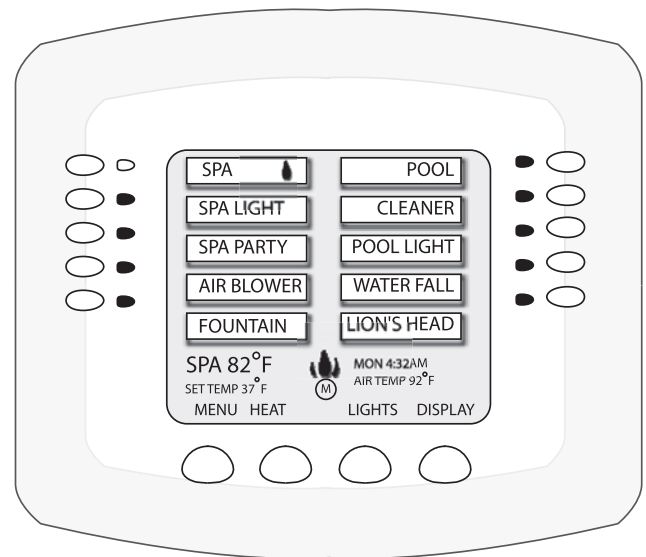
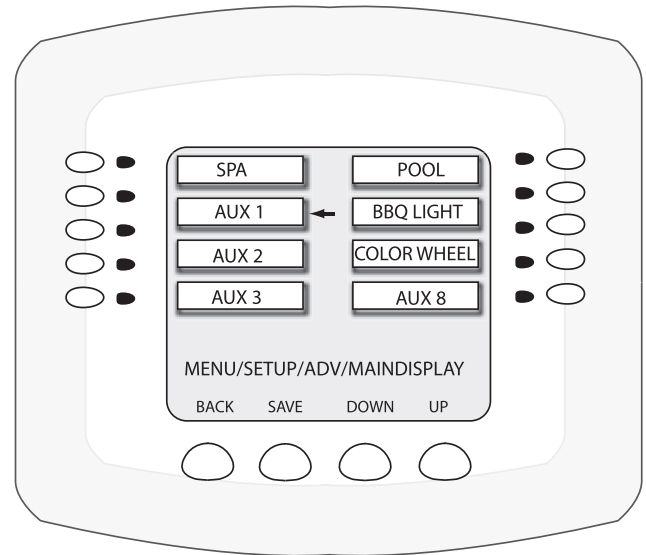



## IntelliTouch Circuit Names

|              |             |   |       |
|--------------|-------------|---|-------|
| AERATOR      | (NOT USED)  | <b>Custom Names</b> (11 characters maximum) |       |
| AIR BLOWER   | OZONATOR    | USER NAME 01                                | _____ |
| AUX 1        | PATH LIGHTS | USER NAME 02                                | _____ |
| AUX 2        | POOL SAM 3  | USER NAME 03                                | _____ |
| AUX 3        | SECURITY LT | USER NAME 04                                | _____ |
| AUX 4        | SLIDE       | USER NAME 05                                | _____ |
| AUX 5        | SOLAR       | USER NAME 06                                | _____ |
| AUX 6        | SPA         | USER NAME 07                                | _____ |
| AUX 7        | SPA HIGH    | USER NAME 08                                | _____ |
| AUX 8        | SPA LIGHT   | USER NAME 09                                | _____ |
| AUX 9        | SPA LOW     | USER NAME 10                                | _____ |
| AUX 10       | SPA SAL     | USER NAME 11                                | _____ |
| BACKWASH     | SPA SAM     | USER NAME 12                                | _____ |
| BACK LIGHT   | SPA WTRFLL  | USER NAME 13                                | _____ |
| BBQ LIGHT    | SPILLWAY    | USER NAME 14                                | _____ |
| BEACH LIGHT  | SPRINKLERS  | USER NAME 15                                | _____ |
| BENCH        | STREAM      | USER NAME 16                                | _____ |
| BLOWER       | STATUE LT   | USER NAME 17                                | _____ |
| BOOSTER PUMP | SWIM JETS   | USER NAME 18                                | _____ |
| BUG LIGHT    | WTR FEATURE | USER NAME 19                                | _____ |
| CABANA LTS   | WTR FEAT LT | USER NAME 20                                | _____ |
| CHEM. FEEDER | WATERFALL   |   |       |
| CHLORINATOR  | WATERFALL 1 |   |       |
| CLEANER      | WATERFALL 2 |   |       |
| COLOR WHEEL  | WATERFALL 3 |   |       |
| DECK LIGHT   | WHIRLPOOL   |   |       |
| DRAIN LINE   | WTRFL LGHT  |   |       |
| DRIVE LIGHT  | YARD LIGHT  |   |       |
| EDGE PUMP    |             |   |       |
| ENTRY LIGHT  |             |   |       |
| FAN          |             |   |       |
| FIBER OPTIC  |             |   |       |
| FIBERWORKS   |             |   |       |
| FILL LINE    |             |   |       |
| FLOOR CLNR   |             |   |       |
| FOGGER       |             |   |       |
| FOUNTAIN     |             |   |       |
| FOUNTAIN 1   |             |   |       |
| FOUNTAIN 2   |             |   |       |
| FOUNTAIN 3   |             |   |       |
| FOUNTAINS    |             |   |       |
| FRONT LIGHT  |             |   |       |
| GARDEN LTS   |             |   |       |
| GAZEBO LTS   |             |   |       |
| HIGH SPEED   |             |   |       |
| HIGH TEMP    |             |   |       |
| HOUSE LIGHT  |             |   |       |
| JETS         |             |   |       |
| LIGHTS       |             |   |       |
| LOW SPEED    |             |   |       |
| LOW TEMP     |             |   |       |
| MALIBU LTS   |             |   |       |
| MIST         |             |   |       |
| MOTOR VALVE  |             |   |       |
| MUSIC        |             |   |       |

## Creating Custom Names for Auxiliary Circuits

There are nearly 100 circuit names stored in the IntelliTouch software (see page 23 for the complete list). If you cannot find one to fit your application you can create up to 20 custom names. To create a custom name, first choose one of the 20 USERNAMES and change it from "USER NAME-01 thru -20" to your name of choice. Like this example, USER NAME-01 could be changed to LION'S HEAD. After you have created and saved your custom names. For details, refer to "Assign a Feature Circuit Name," page 56.

To create a custom circuit name go to the **Create Custom Names** screen.

*Note: If you want to create a custom name you must program the name first.*

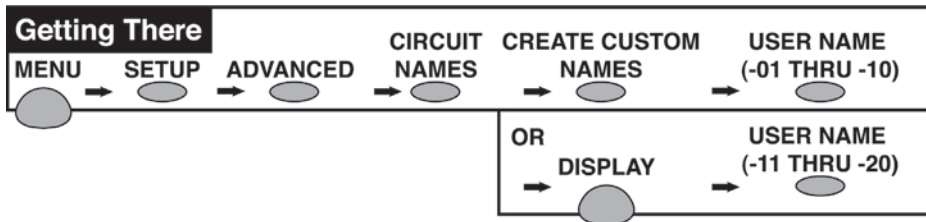

1. Press the button next to the first **User Name** label you want to create. If no custom names have been created, all labels say **User Name -01** through **User Name -20**.
2. Use the **third and fourth button from the top** to find the first letter of the name.
3. Press the button next to **SELECT** once you have found your letter. Then move on to the next letter. Note: You can also enter names in Spanish if required.
4. Press the **Save** button when you are finished. To program another name, repeat steps 1 and 2.
5. Press the **Exit** button to return to the main screen.

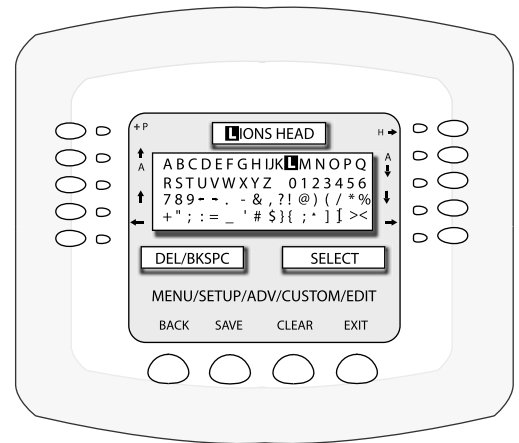

## Assign Circuit Functions and Freeze Protection

Assigning circuit functions allows you set special logic to a circuit. For example, when setting up an automatic pool cleaner pump, you would assign the circuit function MASTER CLEANER. With this "Cleaner" logic the cleaner pump would force the filter pump on, and the cleaner pump would start after a delay of five minutes. The cleaner pump would automatically shut off whenever the spa and solar is switched on with the cleaner pump would be delay for five minutes if energy from the solar is required.

### Freeze Protection

Freeze protection switches on a circuit if the outdoor air temperature sensor detects the temperature is getting close to freezing (below 35° F). The system switches on all circuits that have been assign freeze protection, and runs the circuits for 15 minutes to stop the pipes from freezing. This is especially important if there is a pool and spa combination. If freeze protection is set to both the spa and pool circuits, the filter pump switches on and the pool and spa valves alternate every 15 minutes to keep the water moving in both the pool and spa. This process continues until the freeze condition is over.

### Assigning Circuit Functions and Freeze Protection

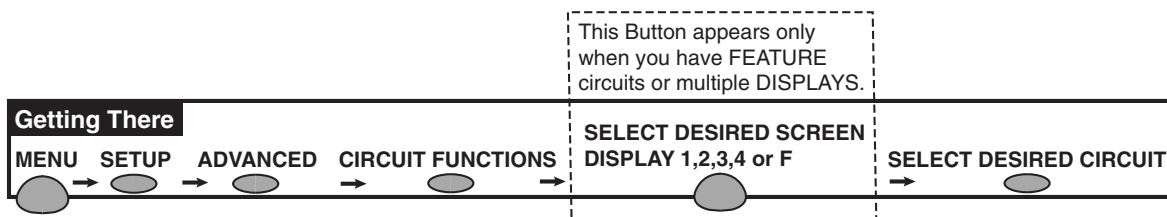

To assign a circuit function:

1. The first line (CLEANER) displays the desired circuit that you wish to assign the function logic to. This circuit is selected from the previous screen.
2. The second line (MASTER CLEANER) shows the type of logic needed for your circuit. Use the **Next/Prev** buttons to select the function. For the complete list of the various types of functions, see "Preset Functions List," on page xx. *Note: You must set pressure cleaners to Master Cleaner circuit function.*
3. The third line shows "ON WITH FREEZE." Select **YES** if circuit is to have freeze protection. If you select YES, the circuit will turn on if air temperature drops to 35° F. Repeat steps 1 through 3 for any other circuits that you want to assign freeze protection.
4. Press **Save** when finished.
5. Press the **Back** button to return to the Circuits screen or press the **Exit** button to return to the Main screen.

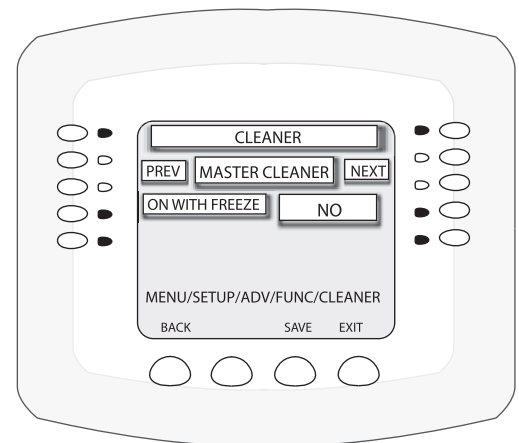

*Note: SAP, POOL, HI-TEMP, LOW-TEMP factory default settings are set to FREEZE "YES."*

## Special Function to a Circuit

|                         |  |
|-------------------------|--|
| <b>Generic</b>          | No special Logic. Simple On/Off control of a circuit with all the programmable capabilities.   |
| <b>Master cleaner</b>   | Works with automatic pool cleaner pumps or cleaner valve actuator. It does the following: <ul style="list-style-type: none"> <li>- Forces the filter pump on 5 minutes before the cleaner.</li> <li>- Turns the cleaner off when the spa is on.</li> <li>- Turns the cleaner off for 5 minutes when the solar heating begins.</li> </ul> |
| <b>Light</b>            | Allows special lighting features to work, such as ALL lights on or ALL lights off.   |
| <b>Dimmer</b>           | Allows light dimming features to work. Dimming relay must be installed.  |
| <b>SAM Light</b>        | Activates special color lighting programs on other screens on the Indoor Control Panel when used with SAM pool lights. For example, you can have ALL lights on or ALL lights off, or use Color Swim, Color Set, or Color Synch.  |
| <b>SAL Light</b>        | Activates special color lighting programs on other screens on the Indoor Control Panel when used with SAL spa lights. For example, you can have ALL lights on or ALL lights off, or use Color Swim, Color Set, or Color Synch.   |
| <b>Photon Generator</b> | Lets Pentair Fiberworks fiber optic bulb be operated by Color Set or Color Swim programs when used with SAM and SAL lighting.  |
| <b>Color Wheel</b>      | Activates special color lighting programs on other screens on the Indoor Control Panel when used with Pentair Fiberworks. For example, you can have ALL lights on or ALL lights off, or use Color Swim, Color Synch, or Color Set.   |
| <b>Valve</b>            | Not currently used.  |
| <b>Spillway</b>         | For pool/spa combinations where the spa is raised above the pool. This setting moves the return valve so that the filter pump pulls the water from the pool and returns it to the spa, creating a water fall effect. Automatic pool cleaners are turned off when this feature is turned on.  |
| <b>Floor Cleaner</b>    | This setting moves a 3-way valve every 20 minutes alternating flow between 2 cleaner system valves that feed the pop-up heads.   |

## Setting up Lighting Options (Color Set and Color Swim) - Requires use of at least two SAm and/or SAL and/or Fiberworks Lighting products controlled by separate AUX circuits

You may group up to 12 light circuits on a special **Lights** screen. The Lights screen is also used to activate the special lighting features. The Color Set and Color Swim special features each must have their own relay and separate circuits. These lighting features are not available for the i5, and i5S systems.

**IMPORTANT:** Before proceeding, make sure the auxiliary circuits (AUX) that control the lights have been assigned names. Then verify that SAm and SAL lights have been assigned in the CIRCUIT FUNCTIONS as SAM and SAL lights. If FIBERworks lighting is being used, it also has to be set up as a PHOTON GENERATOR for the circuit controlling the light bulb, and COLOR WHEEL for the circuit controlling the color wheel (see page 44).

### Color Set and Color Swim

Although the same screen is used to program the **Color Set** and **Color Swim** features, these two special lighting effects operate independently of each other. It may take up to a minute or more for Color Set or Color Swim to operate as programmed, depending on what kind of light you are activating and what state it was in when the effect was activated.

- **Color Set** - Allows any combination of up to 12 SAm, SAL, and/or FIBERworks lighting circuits to be preset to specific colors. For example, you can set the colors for red, white, and blue, or red and green.
- **Color Swim** - Allows any combination of up to 12 Am, SAL, and/or FIBERworks lighting circuits to be preset to transition through colors in sequence, giving the appearance of the colors swimming across the water. The delay in sequencing each light can be adjusted to customize the display for your pool. This feature requires the use of at least two SAm, SAL, and/or FIBERworks lighting products controlled by separate AUX circuits.
- **Sync** - Causes all color changing lights to synchronize their colors.

### Setting up Set Colors and Color Swim with SAm, SAL, or FIBERworks

Both the **Color Set** and **Color Swim** feature are configured on the same Lights screen, but operate independently of each other. It may take up to a minute or more for Color Set or Color Swim to operate as programmed, depending on what kind of light you are activating and what state it was in when the effect was activated. The Color Swim feature create the illusion of bands of color moving through the water by switching on each light with a specific color in a specified order and at different time intervals. The order and time delay between lights can be mixed and matched to create many different effects. For example, colors moving left to right, one body of water to another, from the middle outward, etc.

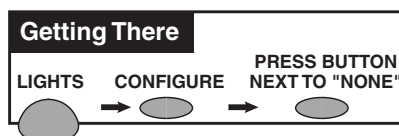

To add circuits to the Lights screen, press the **Lights** button on the bottom of the screen.

1. Press the button next to “Configure.” (Fifth button from the top on the right side).

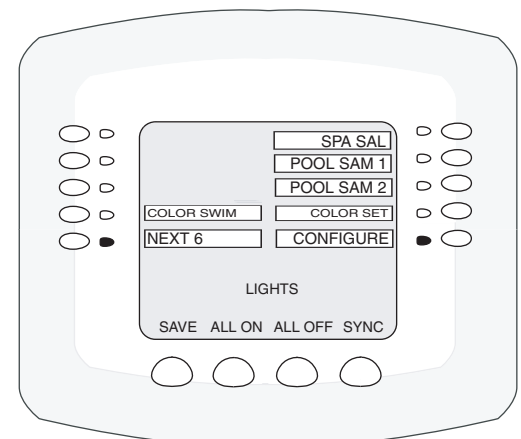

## Setting up Set Colors and Color Swim with **SAm**, **SAL**, or **FIBERworks** (Continued)

2. Press the button next to “NONE” to assign a light circuit to the button.

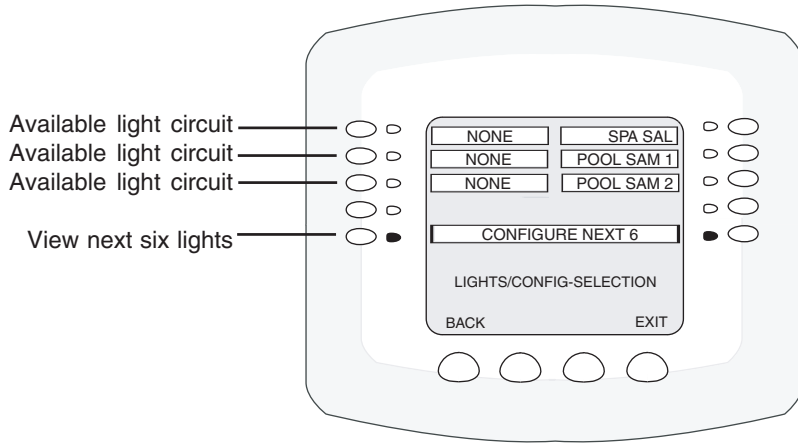

3. Press the top button (either side) to scroll through the possible light circuits which can use Color Set and Color Swim.
4. Select the circuit you wish to set up. The displayed circuit names selections are circuit names that were previously assigned. If there are no circuits available for selection, refer to “Assigning Circuit Names” and “Setting Circuit Functions” on pages 40 and 43 for more information.

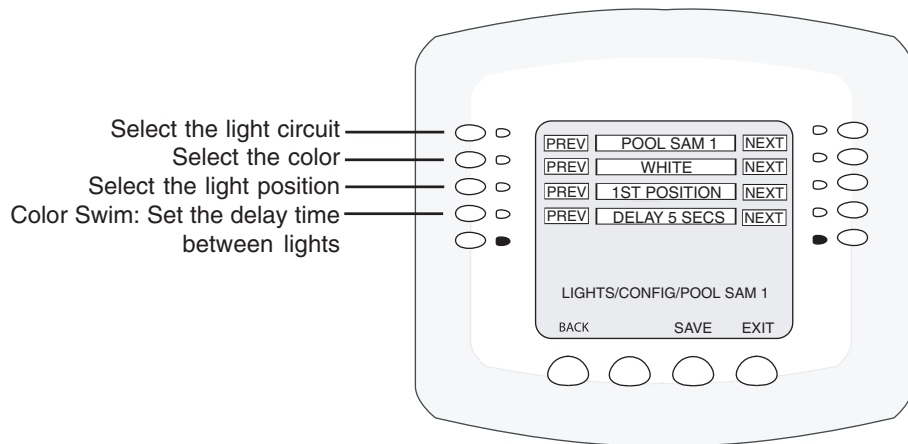

## Setting up Set Colors and Color Swim with SAm, SAL, or FIBERworks (Continued)

5. **Color Set:** Press the second button down from the top to scroll through the color choices. Select the color of your choice. The selections are, White, Light Green, Cyan, Blue, Lavender, and Magenta.
6. **Set Light Position:** Press the third button down from the top to set the position of the first light in the sequence. **Position 1** will lead all the other lights in the color changing sequence. **Position 2** follows Position 1 and so on. More than one light may be assigned to the same position number so that their colors may be synchronized. For example, to make the colors swim right to left, make your right most light POSITION 1. You may need to go back to step 1 and scroll through your lights to find the right most light, and set it as POSITION 1.
7. **Color Swim:** Press the fourth button down from the top to set the time delay between this light and the previous position. Use a higher delay time for lights spread further apart. Try 5 seconds for all lights and observe the effect. Use different time settings to achieve unique lighting moods and effects.
8. Press **Save** to save the current setting for the first light. You will return to the “CONFIGURE-SELECTION screen. To program the next light six lights, press the button next to “CONFIGURE NEXT 6.” Repeat step 1 through 5 to set the light for POSITION 2 for Color Swim, and a new color choice for Color Set. Press Save. Repeat this process until all desired lights have set colors, positions and delays.
9. Press **Exit** when finished configuring the light circuits.

## Setting up Equipment

If any special equipment is attached to the Load Center you need to configure the system to recognize the equipment. You may or may not have this equipment.

The following describes how to set up:

- **Solar or heat pump equipment** - Lets you set solar or heat pump heaters to work (see page 49).
- **Two-speed pump** - Lets you set circuits that switch the filter pump to high speed.
- **Cool-down cycle for the heater** - Lets you set a cool-down cycle for heaters that need it.
- **Automatic spa heating when the spa is manually turned on** - Heats the spa using the Spa button on the Indoor Control panel or the spa-side control, even when the heater is set to OFF in the Heat screen. This lets the homeowner heat the spa on-demand. Timed programs will not heat the spa.

## Manual Priority Override of Timed Program Circuits

A circuit that is programmed to switch off at a certain time of day will always switch off at that time even if the circuit was manually turned on. For example, a circuit has a program that switches it on from 4 PM to 6 PM. The circuit is activated at 3 PM. At 6 PM the circuit will switch itself off and need to be reactivated manually.

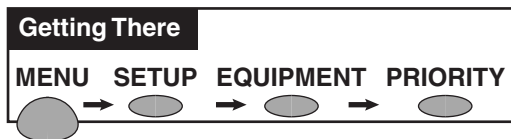

This internal logic may be manually overridden so that a circuit turned on manually will default to the 12 hour time-out instead of turning off at the programmed time.

Go to the Priority screen.

1. Press one of the top buttons next to **Manual Op Priority** until **Yes** displays.
2. Press **Save**.
3. Press **Exit** to return to the main screen.



## Setup Solar Equipment and Heatpump option

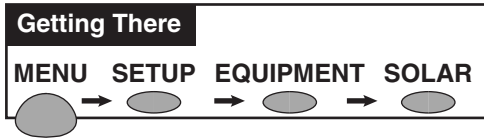

### To set up the solar equipment

*Note: If solar is set then the **Valve A** actuator will be dedicated to the solar valve actuator. Setting the system to Heat pump will free **Valve A** for use on other valves.*

Go to the Solar screen.

1. Press the button next to the “**Water Solar Present**” to change it to **Yes**.
2. If a heat pump is being used instead of a solar heating system, also press the second button to change “**Solar is a Heatpump**” to **Yes**.

*Note: For model i10+3D, press **YES** for each body of water with solar heating.*

3. Press the **Save** button when finished.
4. Press the **Exit** button to return to the main screen.

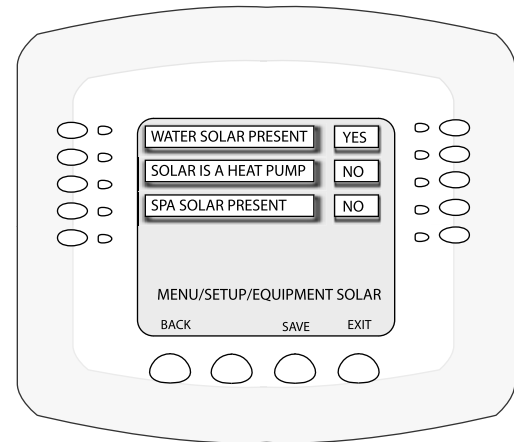
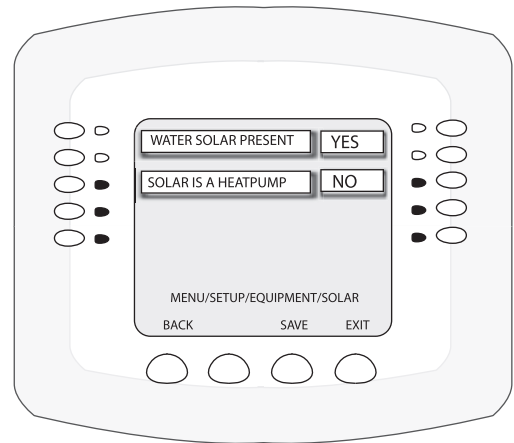

## Setting up a 2-Speed Pump

Equipment circuits displayed on this screen will automatically switch a two speed filter pump to high speed when these circuits are switched on. In this example, the FILTER PUMP will switch from low speed to high speed whenever the JETS or CLEANER is on.

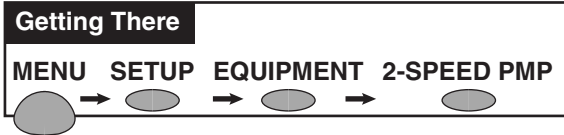

Go to the **2-Speed Pump** screen to select your choice of heat options to force the pump to high speed:

1. Press the button next to a **None** label. The small arrow is pointing to the name of that label.
2. Use the **Up** and **Down** buttons at the bottom of the screen and scroll through the previously assigned names to add another circuit for switching filter pump to high speed. After you have found the desired circuit, you can add another circuit by repeating step 1, or go to step 3. You can use a FEATURE circuit as one of the circuits which can switch the pump to high speed (except for models i5 and i5S).
3. Press the **Save** button. When you find the circuit names that you want, or that will switch the filter pump to high speed.
4. Press the **Exit** button to return to the main screen.

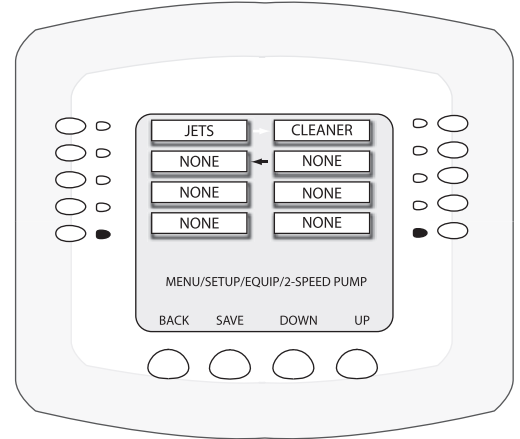

*Note: With a dual equipment system i10+3D, the left column controls the spa pump and the right column controls the pool pump.*

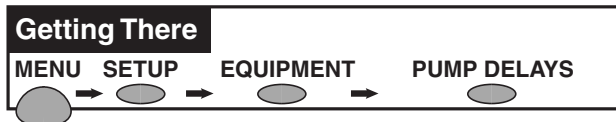

## Set a Cool-Down Cycle for the Heater

Go to the **Pump Delays** screen.

1. Find the **Master Spa/Pool** label. Press the button next to it to change the setting to **Yes**.
2. Press the **Save** button when finished.
3. Press the **Exit** button to return to the main screen.

*Note: Pentair heaters do not require this feature.*

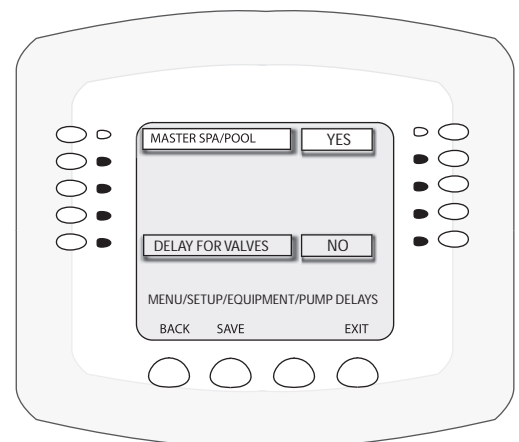

## Delay Cancel Feature

For convenience, on a one time basis, the DELAY CANCEL feature will cancel the following safety delays which can be set up in the IntelliTouch system. Please note there is generally not a need to cancel any of these delays except for servicing or testing the system.

- **Heater Cool-Down Delay Cancel:** Shuts Filter Pump off immediately.
- **2-Speed Filter Pump 5 minute START on HIGH SPEED Delay Cancel:** Shifts pump to low speed.
- **Automatic Pool Cleaner START Delay:** Starts Cleaner Pump immediately. Normally there is a delay in which the filter pump first runs for 5 minutes before the cleaner pump starts.
- **Automatic Pool Cleaner-SOLAR Delay:** Allows Cleaner Pump to run even though solar delay has shut it off for 5 minutes.

About the Heater Cool-down Cycle and Delay Cancel

Some heaters require a cool-down cycle before being turned off. This can be accomplished with a SET UP procedure in the IntelliTouch system which runs the filter pump an additional ten minutes to dissipate residual heat built up inside the heater combustion chamber. The DELAY CANCEL feature is mainly for use by service technicians when they want to shut the filter pump off immediately, and know the heater has not been running.

**IMPORTANT:** Heaters manufactured by Pentair Water Pool and Spa do not require this cool-down period and do not need the delay to be set up.

To cancel a safety delay:



Go to Delay Cancel Screen

1. Press the button next to the **Delay** label. The selected equipment is switched off and the pool is ready to be serviced.
2. Press the **Back** button when finished. The Delay switches off and your system is set back to normal.

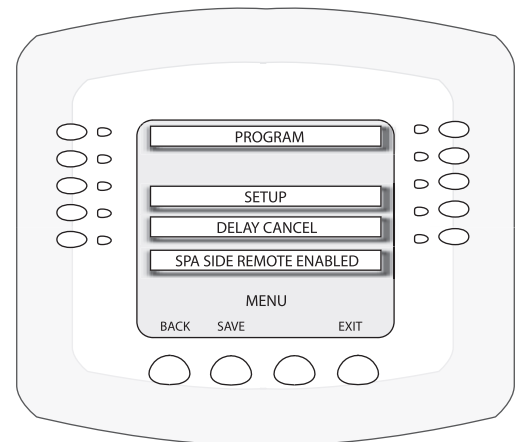

## Set Automatic Spa Heating When the Spa is Manually Switched On

Go to the **Manual Heat** screen.

### Getting There

MENU → SETUP → EQUIPMENT → MANUAL HEAT

1. Find the **Spa Manual Heat** label. Press the button next to it to change the setting to **Yes** (default setting).
2. Press the **Save** button when finished.
3. Press the **Exit** button to return to the main screen.

*Note: If you do not want the heater to switch on when you press the SPA button, change the factory setting from YES to NO.*

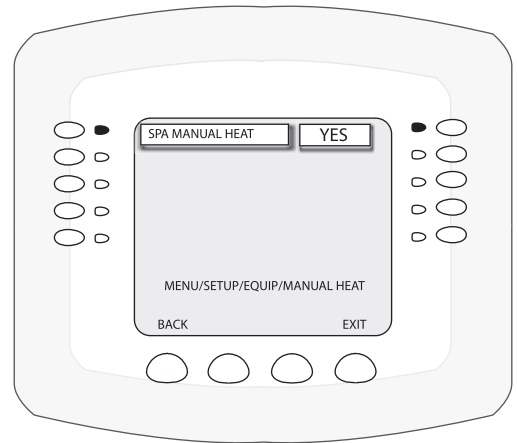

## Changing the Display to Show Fahrenheit to Celsius

You can change the temperature settings to show either Fahrenheit or Celsius.

### Getting There

MENU → SETUP → EQUIPMENT → DEGRESS C/F

To change the temperature settings go to the **Degrees C/F** screen.

1. Find the label next to the **Degrees Displayed In** button.
2. To change the setting to the either **Fahrenheit** or **Celsius**, press the button next to the label.
3. Press the **Save** button to save your settings,
4. Press the **Back** button when finished.

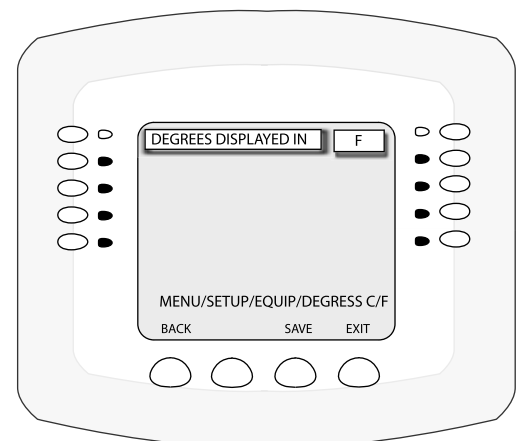

## Chlorine Generator

The IntelliTouch system is designed to operate with the following salt chlorine generators:

- **IntelliChlor**
- **GoldLine Aqua Rite**
- **Clear Tech Automation AutoClear Plus**
- **AutoPilot Pool Pilot Digital**

*Note: Call your manufacturer for compatibility with IntelliTouch systems.*

### Activate the Chlorinator Control Interface

Before operating the chlorinator control interface you must first activate the system to control the chlorinator from the IntelliTouch Indoor Control Panel. The IntelliTouch system can control the chlorinator but does not turn the chlorination system on or off. When the chlorinator control is enabled, the chlorinator can only be operated by the IntelliTouch. When the chlorinator control is disabled, the chlorinator is still operating but must be controlled at the chlorinator control panel.

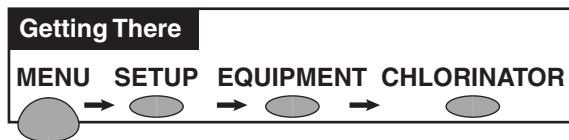

To obtain chlorination status and make adjustments:

Go to the Chlorinator screen.

1. Press the button next to **Control Enabled** until **Yes** is displayed.
2. Press **Save**.
3. Press the button next to **Chlorinator** to display the chlorinator screen. At the top of the screen your brand of chlorinator is displayed.
  - **STATUS line:** Describes the current chlorinator operating condition. Any error codes will display here.
  - **WATER SALT LEVEL:** Displays how much salt (in parts per million (ppm)) is in the water. See chlorinator manufacturer's instructions for recommended salt levels.
  - **OUTPUT LEVEL (0 -100%):** Displays the chlorination output level from 0 to 100%. Press the button next to UP or DOWN button to increase or decrease the chlorination output level.
  - **CONTROL ENABLED:** Press the button next to **YES** until **NO** is displayed to disable the control of the chlorination interface from the Indoor Control Panel.
4. Press **Exit** to return to the main screen.

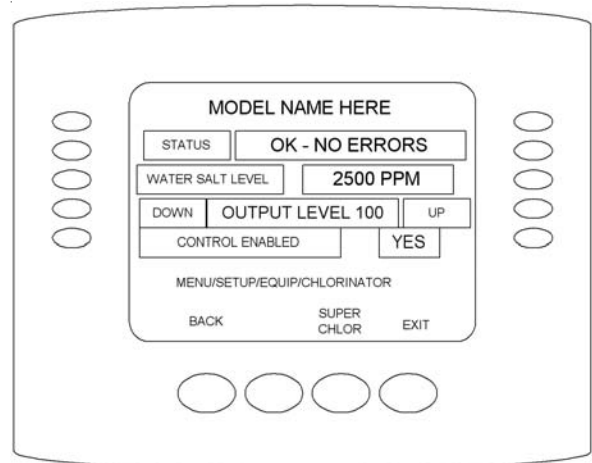

## Changing the Chlorinator Output

The IntelliTouch system will automatically drop the chlorine output levels to 1/20 the output when the Spa mode is switched on. For example, if the output level is set to 60%, when Spa Mode is switched on, the chlorination level is reduced to 3%.

To change the chlorine output level:

Go to the Chlorinator screen.

1. Press the buttons next to **Output Level** to raise or lower the output level. The level displays the 0 to 100%.
2. Press **Save** when done.
3. Press **Exit** to return to the main screen.

## Super Chlorinate the Pool

At the start of the pool season or after long periods of disuse you may want to “super chlorinate” the pool to prepare it for swimming.

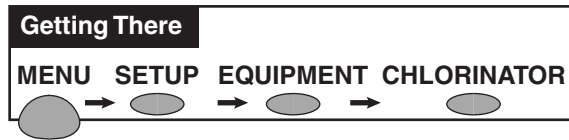

Go to the Chlorinator screen.

1. Press the bottom button next to **Super Chlor**.
2. The default run time for super chlorination is 24 hours. Press the buttons next to Hours to Run to change the run time of super chlorination mode.
3. Press **Save** when done. The chlorinator will automatically start super chlorination and switch on the filter pump. When done the system will return to normal.
4. **To cancel super chlorination:** Go back to the Chlorinator Screen. The time left for super chlorination is displayed.
5. Press the button under Cancel **Super Chlor**.
6. Press **Exit** to return to the main screen.

***Note:** For information about wiring a salt chlorine generator to the IntelliTouch system, see “Wiring IntelliTouch to a Salt Chlorine Generator,” on page 90.*

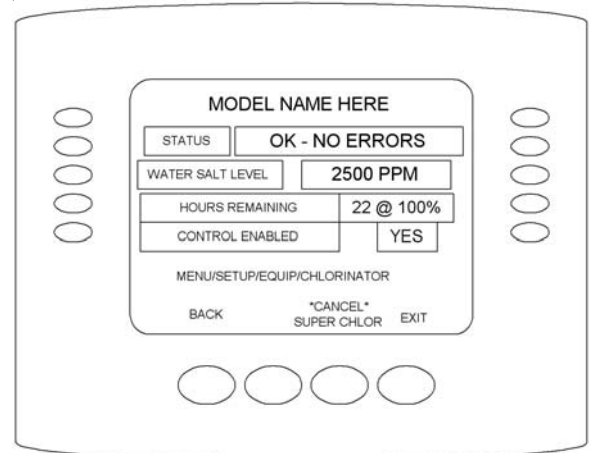
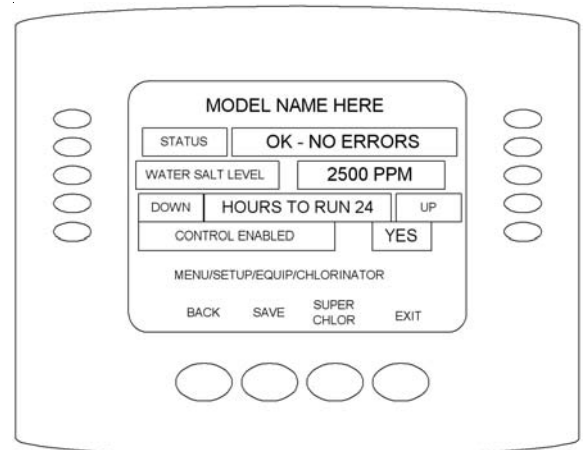

## Configuring Valve Actuators (Controlled by AUX or Feature Circuit)

All IntelliTouch systems can drive two auxiliary valve actuators (A and B) for applications such as solar heating and water features. With the addition of the Valve Module (P/N 520285), installed in the Load Center or Power Center, the system will accommodate up to three additional actuators (C, D, and E). An **AUX** circuit or **FEATURE** circuit can control auxiliary valve actuators. Please note that the i5 and i5S models do not include **FEATURE** circuits and therefore must use the **AUX** circuits for controlling valve actuators. By using Feature circuits to control valve actuators, you can conserve your **AUX** circuits for high voltage relays for controlling pumps and lights. Use Macros to couple valve actuators with **AUX** circuits for specific applications.

*Note: All Personality boards (including i5x and i10x) has two valve outputs A & B. With the addition of the Valve Module (P/N 520285) board that connects to the Personality board, three additional valve operators can be added to the system.*

### Configuring Valve Actuators

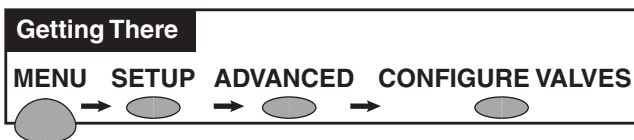

*Note: If Expansion Centers are a part of the system, before this screen, you must select which main Load Center or Power Center you wish to configure. The Load Center or Power Center number matches display number (1 through 4).*

Go to the Configure Valves screen.

1. Select the button next to the valve actuator you wish to configure. Keep pressing the button until you find the circuit name which you would like to use to control that valve actuator.

**Valve A:** Resides on the Personality board. If solar heating is setup AND NOT configured as a heat pump, then this valve is dedicated for controlling the solar heating valve actuator.

**Valve B:** Resides on the Personality board next to Valve A.

**Valves C, D, E:** Reside on the optional Valve Module board that may be plugged into the Personality board in any Load Center or Power Center.

2. Repeat the above steps for each valve actuator.
3. Press **Save** when done.
4. Press **Exit** to return to main screen.

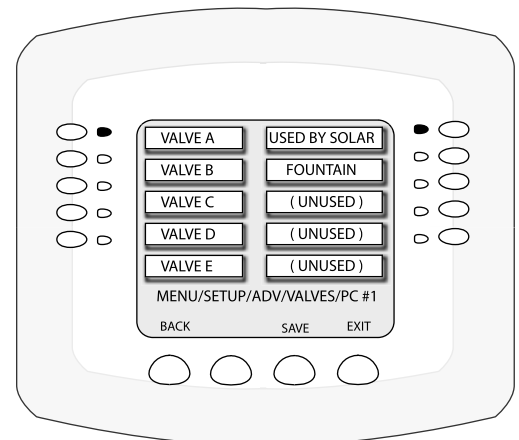

## Feature Circuits

Feature Circuits provide a way to control a piece of equipment, which is not controlled by an AUX circuit. Typically AUX circuits are used for high voltage equipment such as pumps and lights, whereas Feature Circuits are used for valve actuators. However, Feature Circuits can go beyond this definition, and be used in other creative ways. For example, Feature Circuits may be used to create a Macro circuit in which several other circuits can be switched on or off with the same button. This is accomplished by first choosing a name for your Macro and assigning that name to a Feature Circuit. There is a limit of 10 Feature Circuits in the system. Macros are not available with i5 or i5S systems.

- **Valve Actuators** - Feature Circuits may be assigned for controlling up to five valve actuators per Load Center, which requires the installation of the optional Valve Module P/N 520285 that include three actuators outputs (C, D, and E) per Load Center. For more information about configuring valve actuators, refer to page 28.
- **2-Speed Pump** - A Feature Circuit may be assigned as a way to turn a 2-speed Filter Pump to high speed.
- **Spa Spillway** - A Feature Circuit may be assigned to activate the Spa Spillway effect, where in a pool/spa combination, all of the pool water can be diverted to the spa then spill back into the pool.

## Assign a Circuit Name to a Feature Circuit (not available for model i5 or i5s)

*Note:* Use the written list of circuit names and assigned buttons (**button 1**) on the Outdoor Control Panel that you made while setting up the system. The circuit names you assign in the Indoor Control



Panel must match the button labels on the Outdoor Control Panel.

1. Press the button next to the circuit that you wish to assign a name. A small arrow pointing to the name is displayed.
2. Use the **Up** and **Down** buttons to scroll through the list of alphabetical programmed names. If you cannot find a name to match your circuit, you can create your own custom name by going back to the **CREATE CUSTOM NAMES** screen. For a complete list of the IntelliTouch Circuit Names, see the following page.
3. Repeat step 1 and 2 for all the buttons you wish to assign names to. Continue to assign the other circuits. Depending on the model you are programming, equipment may not be installed for all available circuits shown on the screen.
4. Press the **Save** button when you are done assigning names.
5. Press the **Exit** button to return to the main screen.

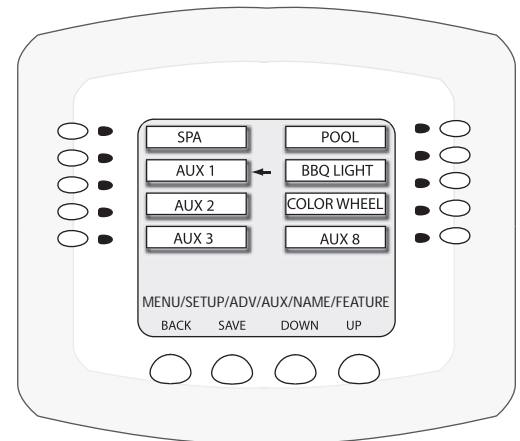



## Create a Macro

Macros give you the ability to combine various circuits together so a single button can operate them all at once. For example, you could create a Macro that would give you one button that turns on your spa, spa light, fountain, fountain light, and patio lights. You can assign a name to your Macro from the list of IntelliTouch circuit names. For the complete list of names, see “IntelliTouch Circuit Names,” on page 41. You can also create your own custom name, like SPA PARTY for example. A Macro also has the capability to switch a circuit off. So in this SPA PARTY example, if there was a spa fountain which should not be on when spa is on (because it could put cold water in the spa) it can be set up in the Macro to automatically switch off when SPA PARTY is switched on. An OFF Macro can also be used to switch any number of lights off with one button. To create a Macro, first assign a **feature circuit name**, see page 56), assign the function name for the feature circuit, then go to the **Circuit Macros** screen and set up your Macro.

*Note: Macros may not be set as Dimmers although they can turn on light dimming circuits.*

To create a macro, go to the **Circuit Macro** screen.

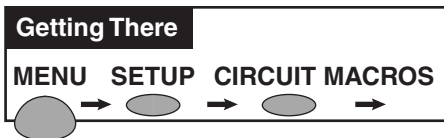

1. Select the button next the label you created. Press the button next to the circuit you want to assign to this macro. If your system includes more than 10 circuits, press the **Display** button to view the next screen of circuits.

  - To switch a circuit ON, press the button next to the circuit name one time. The light is on.
  - To switch a circuit OFF, press the button next to the circuit name two times. The light blinks on and off.
  - To set a circuit to be unaffected by the macro, press the button next to the circuit name three times. The light is off.

*Note: Be careful when you select circuits to switch on. One macro circuit can switch on another macro circuit, resulting in systems switching on or off that you do not want on or off.*

2. Press the **Save** button when finished.
3. Press the **Exit** button to return to the main screen.

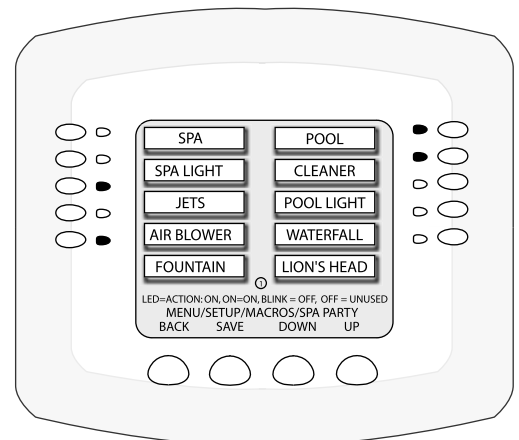
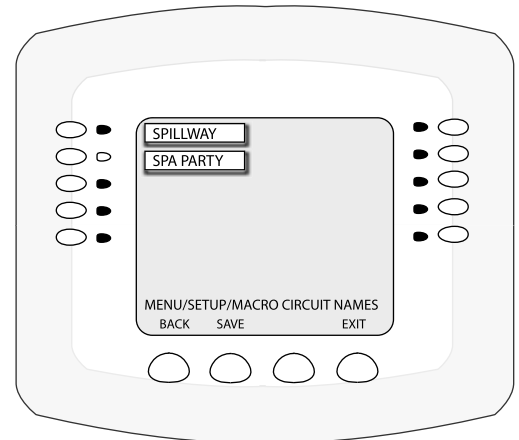

## Configuring Remote Control Button Circuits (iS4, iS10, QT4 QuickTouch, and Phone Remote)

You can specify any Spa-Side remote button to control different functions. Each Spa-Side remote has a slightly different screen, however, all screens configure the same, regardless of how many buttons the remote has.

To configure the Spa-Side remotes:

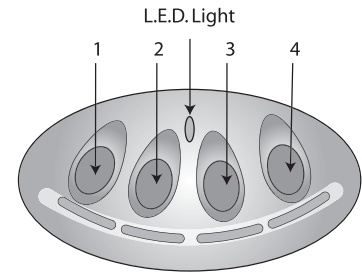

*iS4 Spa Side Remote*

1. Press the button next to **CONFIGURE iS4'S** or **CONFIGURE iS10'S** or **CONFIGURE QUICKTOUCH** to select the remote.

- **For iS4:** Press the top button to access the iS4 setup screen.
- **For iS10:** Press the second button from the top to select **iS10 #1** for the first iS10. Choose which one of the four iS10's you are configuring, **iS10 #2**, **iS10 #3**, or **iS10 #4**.

- **For QuickTouch:** Press the third button from the top to access the "CONFIGURE QUICKTOUCH" setup screen.
2. On the remote's specific screen, press the button next to the circuit you want to change. You see a small arrow pointing to the name of that circuit.
  3. Use the **Up** and **Down** buttons at the bottom of the screen to scroll through the previously assigned circuit names.
  4. When you find the circuit you want, press the button next to another Spa-Side control button circuit you want to change. The small arrow moves to that label. You are done setting the first spa-side control button circuit and are ready to set the next.

5. Continue the process to assign other circuits to the spa-side control buttons.
6. When you are done assigning circuits to the buttons on the Spa-Side remote, press the **Save** button.
7. Press the **Exit** button to return to the main screen. You can press **Back** to go back to the remotes screen and configure another remote.

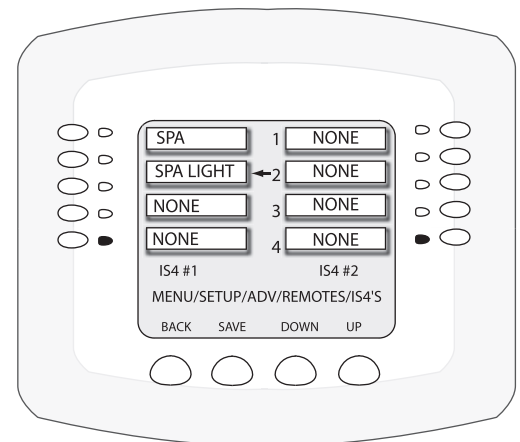

*Configured for iS4*

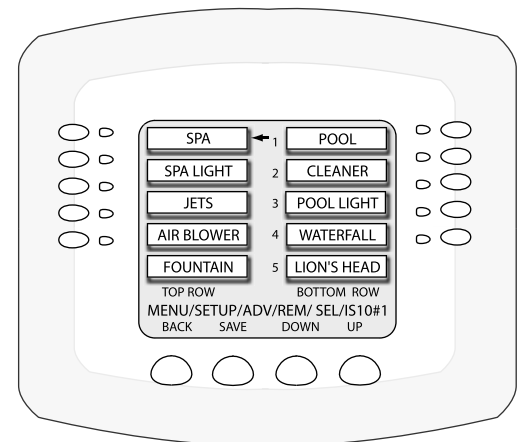

*Configured for iS10*

## Setting up the Remote Control Telephone Feature

The remote control telephone feature allows you to switch on a feature by calling the Indoor Control Panel via the telephone.

You can only use this feature if you have the **TELSPA** installed in the Load Center or Power Center, connected to the Personality board, and connected to your phone line.

The following describes how to switch on your spa remotely. However, you can scroll through the list of available features and set any one of them. You can also use a macro circuit (see page 57).

To setup the telephone remote control:



Go to the **Spa RF and Phone Remotes** screen.

1. Press the fourth button from the top (**CONFIGURE MOD-PHONE**) to access the Phone Remote setup screen.
2. Press the top left button so that the arrow appears to the right of **NONE**. If this is the first time you have set this feature, **NONE** is displayed.
3. Press the **Up** or **Down** buttons to scroll through the available circuit names until you find the function you would like to assign to the telephone remote. Choose the function you will use most often, for example **SPA** allows you to call the system and switch on spa filtration and heating with one command.

***Note:** If you are using the remote to turn on your spa, you must also set up the spa for **MANUAL HEAT**. This allows the heater to always switch on whenever the spa is switched on via the telephone. For more information, see page 52.*

4. Press the **Save** button to save the setting. The remotes screen displays.
5. Press the **Exit** button.

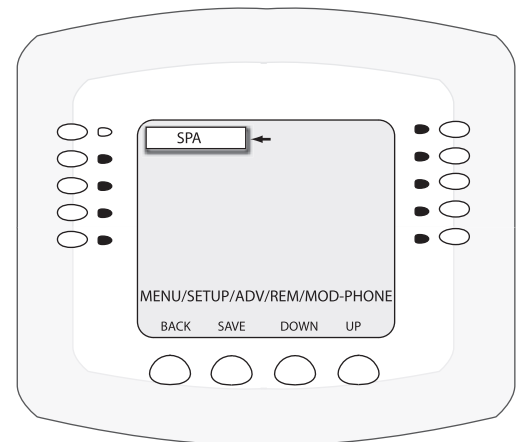

## Disable/Enable Spa-Side Remote

This feature is useful for families with young children. It gives you an easy way to switch off the Spa-Side Remote so it cannot affect the system. You can enable and disable the Spa-Side Remote with the same button. Each time the button is pressed it toggles to either DISABLED or ENABLED.

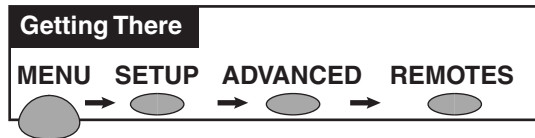

Go to the **Spa Side Remote Disable/Enable** screen

1. **To Disable:** Press SPA SIDE REMOTE ENABLED. Screen will immediately respond and display SPA SIDE REMOTE DISABLED. Remote is now off.  
  
**To Enable:** Press SPA SIDE REMOTE DISABLED. Screen will immediately respond and display SPA SIDE REMOTE ENABLED. Remote is now on.
2. Press the **Back** button when finished.

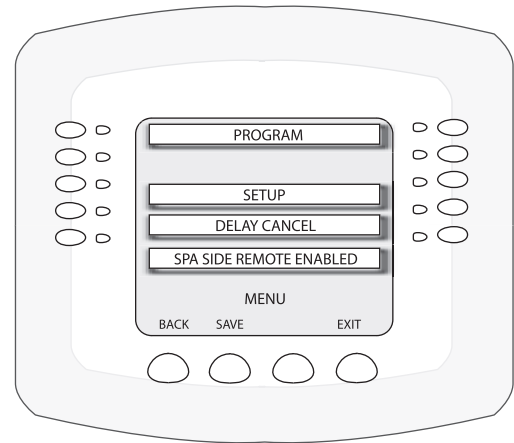



## **Service and Maintenance**

## Calibrating Temperature Sensors

The IntelliTouch system includes two temperature sensors (10 k $\Omega$ ) for water and ambient air temperature. You can add a third sensor for controlling solar heating systems. Note: The i10+3D system includes three sensors.

Generally, these sensors are accurate and you do not have to calibrate them. However, long plumbing runs and water features cause temperatures at a body of water to be different from the temperature sensor reading. You can manually recalibrate the sensors to adjust for this.

Before you start, you need an accurate all weather thermometer. If you are calibrating the air sensor, wait until the sensor is not in direct sunlight. Ensure that the air sensors are located in the shade for accurate freeze protection.

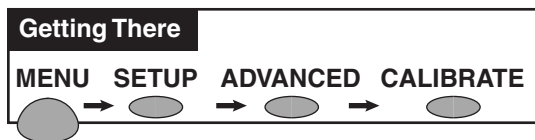

To calibrate the sensors, go to the **Calibrate** screen.

There is a Water Temp and Air Temp setting. If you have an i10+3D system, you will see **Spa Temp**, **Pool Temp**, and **Air Temp**. Calibrate the Spa and Pool temperatures the same way as described below for Water Temp. If you have an i5, i5S, i7+3, or i9+3 system, there will be one sensor water and one for air temperature. Make sure to locate the air sensor in the shade for accurate readings. Make sure to locate the solar sensor in the sun for accurate readings.

To calibrate the water sensor:

1. Switch on the spa or pool filter pump.
2. Place the thermometer in the spa or pool, depending on the system model number. For shared equipment, you only need to calibrate one body of water.
3. Take an accurate temperature reading.
4. At the Indoor Control Panel, press the buttons next to the **Water Temp** label to adjust the temperature up or down. If you have an i10+3D repeat the above for the pool. The i10+3D has three sensors, one each for the spa and pool water and one for the air temperature. For the Solar option there will be one sensor for the pool solar, and one for the spa solar.
5. Press the **Exit** button when finished.

To calibrate the air sensor:

1. Place the thermometer next to the air sensor. The sensor is normally located near or under the Load Center or Power Center enclosure, not inside the enclosure.
2. Take an accurate temperature reading in the shade.
3. At the Indoor Control Panel, press the buttons next to the **Air Temp** label to adjust the temperature up or down.
4. Press the **Exit** button when finished.

## Using the Service Personnel Screen

IntelliTouch system information such as circuit configurations is retained in the Outdoor Control Panel memory. System information relating to user interface settings and ordering of controllers is retained locally at the controller (Indoor Control Panel, MobileTouch, iS10 etc.). All system information is backed up and updated to all Indoor Control Panels, MobileTouch controllers, and the main Outdoor Control Panel periodically. If required, you can upload or down load the current system configuration to and from the Outdoor Control Panel and controllers. This feature is available from the Service Personnel screen.

### Checking Firmware Version

The IntelliTouch factory installed operating system software is known as firmware. There is a different firmware program loaded on the controllers (Indoor Control Panel and MobileTouch) and the Outdoor Control Panels. Every time the firmware version is changed it is assigned a new release level number (version #). Changes are made to the firmware to either add functionality or enhance performance. If you need to determine the firmware release level on your system perform the following steps.

To check the system firmware version:



Go to the Advanced screen.

1. From the Advanced screen, press **buttons 2 and 4 at the same time**. The Service Personnel screen is displayed.
2. Press the **System Version Info** button. The firmware version is displayed for the Indoor Control Panel and Outdoor Control Panel. Note: UOC is Outdoor Control Panel. UIC is Indoor Control Panel
4. Press **Back** to exit.
5. Press **Exit** to return to the main screen.

***Note:** Different controllers may have different release levels depending on when they were installed. To determine the release version of each controller repeat the above steps for each controller.*

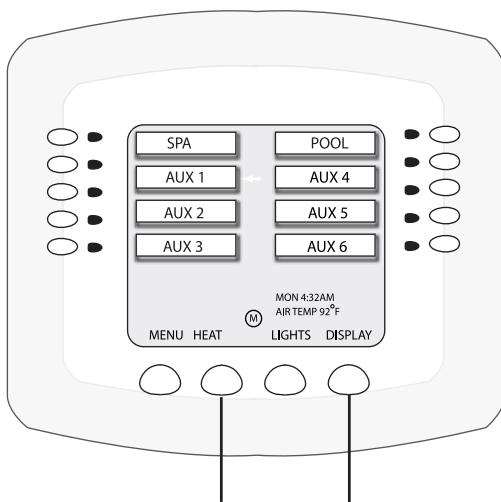

Press both buttons at the same time to access the Service Personnel screen

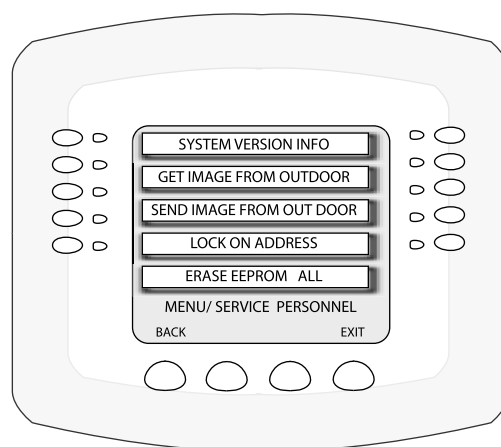

## Manually Updating Between Indoor and Outdoor Control Panels

When an update is made to the system configuration or a new component is added the system will automatically communicate the updated information to all the other controllers. System configuration settings reside in all controllers and the Outdoor Control Panel. This facilitates configuration retrieval in the event one of the controllers or control panels is damaged. A system configuration update may be forced immediately by doing the following:



To update system configuration information between controllers:

Go to the Advanced screen.

1. From the Advanced screen, press the **2nd. and 4th. buttons at the same time**. The Service Personnel screen is displayed.
2. Press **Get Image from Outdoor** to download a system configuration residing in the Outdoor Control Panel memory.
3. Press **Send Image to Outdoor** to download a system configuration residing in the controller at hand. You may see a stopwatch clock flash indicating memory transfer.
4. When the transfer is finished, press **Back** to exit.
5. Press **Exit** to return to the main screen.

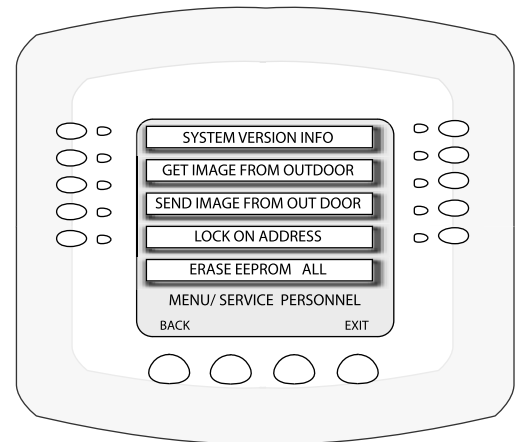



## Erasing the System Memory

The IntelliTouch system includes dual micro processors, one on the Outdoor Control Panel, and the other on the Indoor Control Panel. System information relating to circuit configuration, operation and display is retained at the main Outdoor Control Panel and all Indoor Control Panels and MobileTouch controllers. System information automatically downloads from programmed components to non-programmed components in case of accidental memory loss and to ease board replacement, system programmed memory can be erased and returned to the factory default settings. Once this is done, the main Outdoor Control Panel (located in the main Load Center or Power Center) will auto-enable all connected wired controllers. If there are multiple Expansion Center, iS10's, or Indoor Control Panels or a MobileTouch, each one of the controllers will need to be manually enabled.

To reset to the system to the factory default settings:

**CAUTION:** This procedure will erase all system settings. All controllers will need to be manually enabled again. If more than one wired Indoor Control Panel, MobileTouch, or Expansion unit (2, 3, or 4) is added, the system must be in "AUTO" mode.

1. On the main Outdoor Control Panel (located in the main Load Center or Power Center), press the **Reset button**. All the System Control lights turn on.
2. Press **5**. The System Control lights flash OFF and then back on.
3. While the System Control LED lights are on, press **1**.
4. The System Control LED lights flash.

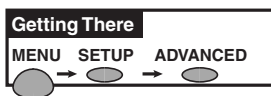
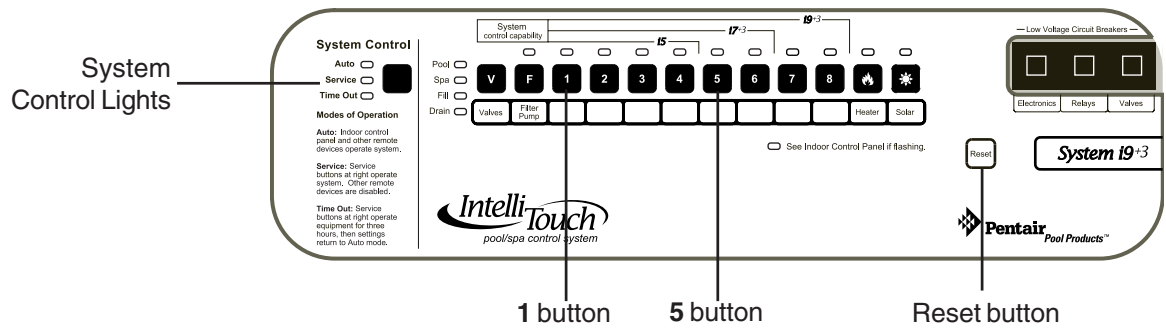

Go to the **Advanced** screen.

5. From the Advanced screen, press **buttons 2 and 4 at the same time**. The Service Personnel screen is displayed.
6. Press either button next to **Erase EEPROM All!!**
7. When asked if you are sure you want to do this press **YES**.
8. Then select **ERASE**. The screen will blink a few times then return to the main screen. All system configuration data should now be erased.
9. Repeat this step with each controller.
10. At the Outdoor Control Panel press **Reset** and wait for the system to return to "AUTO" mode.

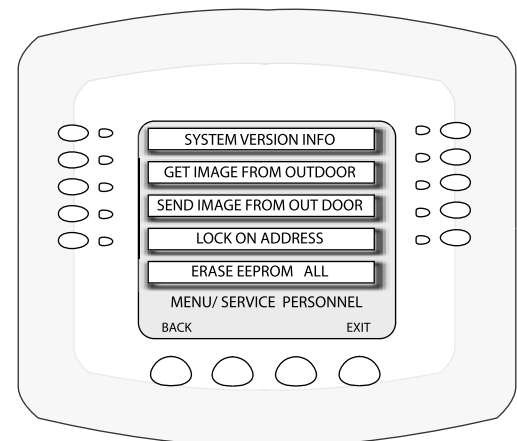

## Manually Enable an Indoor Control Panel

### About DISPLAY Screen 1, 2, 3, 4

The auxiliary circuits that control the pool and spa equipment can be accessed from the Indoor Control Panel Displays screen. Pressing Display 1, 2, 3, or 4 will put you in the screen with circuits belonging to that particular Load Center or Expansion Center. The **Feature Display** assigns Feature Circuits. The Displays screens are as follows:

- **Display 1** - This screen shows the filter pump, pool and spa modes, and all high voltage auxiliary circuits connected to the Load Center or Power Center.
- **Display 2** - This screen shows additional auxiliary circuits connected to the first Expansion Center.
- **Display 3** - This screen shows additional auxiliary circuits connected to the second Expansion Center.
- **Display 4** - This screen shows additional auxiliary circuits connected to the third Expansion Center.

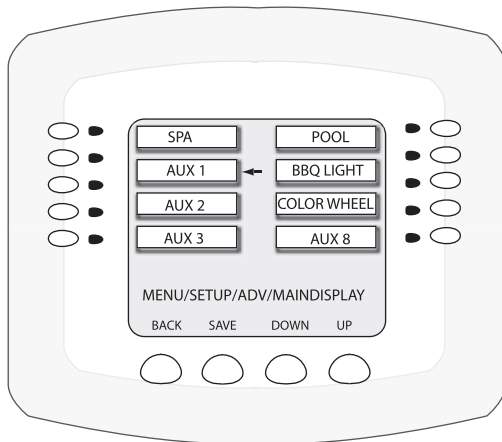
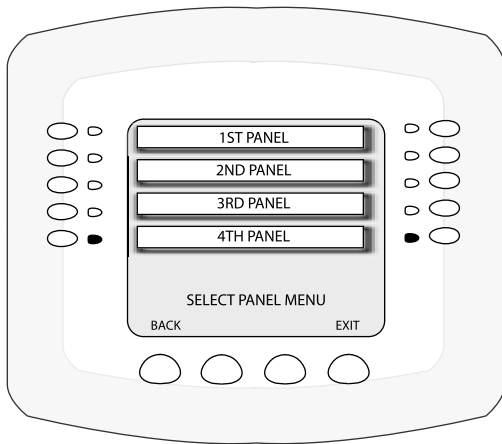

## System Worksheet Overview

System worksheets are provided to help you plan the system at start-up. Make copies of each system worksheet (page 61 - 66) appropriate for your system and use a unique one for each Load Center or Power Center. Circle the Load Center or Power Center number on the top. Each worksheet is divided into a **Hardwired Connections** and a **Programmable Settings** sections. The Hardwired Connections section represents which relays, actuators, and heater have been plugged into the Personality board. Some connections are mandatory for each system as shown on the work sheet. The Programmable Settings section represents what functionality the circuit will have and is set from any Indoor Control Panel and/or MobileTouch control panel independent of the hardwired connection.

In the left-side column, write-in temporary circuit names based on the capabilities you want the system to have. For example: Spillway, Solar Heating, Cherub Fountain, etc. Eventually circuit names will be given to each of these capabilities. Although duplicate names can be used, it is best to keep each one unique. Be sure to write the circuit name on the work sheet that will have the hardwired connection.

Mark on the worksheet which Hardwired Connections (relay or valves) will be activated by the circuit. It may be helpful to fill this out at the Load Center or Power Center where the circuits and associated equipment may be quickly verified. Remember the following rules to assist in making marks:

- Assign no more than one relay connection to any auxiliary circuit (shown on Display 1 through 4) EXCEPT for 2-Speed or Feature Circuits.
- Feature Circuits may have multiple relay connections if set up as a Macro.
- Feature Circuits may have multiple valves assigned to them and 2-Speed without being set up as a Macro and with no other relay connection.
- Valves A-E may be assigned to the same auxiliary circuit as a relay connection.
- If one valve is to be turned on by more than one circuit, then it is suggested to assign a Feature Circuit to just that valve. That valve and any combination of relay connections may be activated with Macros.
- If SOLAR relay connection is checked and SOLAR is **NOT** a heat pump, also check Valve A. Valve A may not then be used with any other circuit. Valve A and the SOLAR relay are activated when solar heating is enabled.

Mark Programmable Settings for each circuit. Mark what special Circuit Functions, if any, each circuit will have. Circuit Functions may be assigned to any number of circuits. For a detailed description of Circuit Functions, see page . If Spillway is checked, the Intake and Return valves will turn to divert all the pool intake water to be returned to the spa. If “Floor Cleaner” is checked, then one or more valves must also be checked to run the floor cleaner multi-port valves. If no special function will be assigned check GENERIC.

Write-in any automatically timed programs you want for a circuit. Up to 99 total timed programs may be assigned, but only three are presented on the work sheet. Indicate start times, stop times, countdown time (called “EGG TIMER”), days to be active, and if a color changing light whether or not it should change colors when turned on (SMART START).

Finally, indicate what circuits you want to appear on the Indoor Control Panel main screen and what circuits you want activated by what buttons on a Spa-Side remote. The top buttons of the main screen are dedicated for Spa and Pool modes, however the lower buttons numbered downward may be configured to display any circuit.

***Note:** The homeowner should keep the system worksheet for future reference.*

## WORKSHEET FOR SHARED EQUIPMENT SYSTEMS i5, i7+3, i9+3 (Sheet 1 of 2)

| HARDWIRED CONNECTIONS  |  | PROGRAMMABLE SETTINGS   |  |
|--|--|---|--|
| RELAY CONNECTIONS  |  | SPA-SIDE REMOTES  |  |
| CIRCUIT NAME   | VALVES   | CIRCUIT FUNCTIONS   | IS10 BUTTTON   |
| POOL (may be renamed)<br>SPA (may be renamed)                      | INTAKE VLV<br>RETURN VLV   | OPT. VALVE MOD.   | CIRCLE ONE: #1 #2 #3 #4  |
| FLTR PMP   | VALVE A<br>VALVE B<br>VALVE C<br>VALVE D<br>VALVE E  | GENERIC<br>MASTER CLNR<br>LIGHT<br>DIMMER<br>SAM LIGHT<br>SAL LIGHT<br>PHOTON GEN<br>COLOR WHEEL<br>VALVE<br>SPILLWAY<br>FLOOR CLNR | IS4 #1 BUTTTON<br>IS4 #2 BUTTTON<br>TOP ROW<br>BOTTOM ROW  |
| <p>Create Custom Names At:<br/>MENU/SETUP/ADV/<br/>CUSTOMWEDIT</p> | <p>Assign Circuit Names At:<br/>MENU/SETUP/ADV/<br/>AUX NAMES/DISPLAY 1-4 OR<br/>FEATURE<br/>NOTE: POOL and SPA may be renamed but they always activate the circuits indicated</p> | <p>Configure At:<br/>MENU/SETUP/EQUIP<br/>NOTE: If SOLAR is checked also check VALVE A, unless SOLAR is a Heat Pump</p>             | <p>Assign Circuit Functions At:<br/>MENU/SETUP/ADV/FUNC/<br/>"Circuit Name"<br/>NOTE: Use DISPLAY to toggle through Display 1-4 and Feature Circuits<br/>NOTE: If MASTER CLNR is checked FLTR PMP will also turn on; If DIMMER is checked also assign an AUX; If SPILLWAY is checked, RETURN VLV operates; If FLOOR CLNR is checked also assign VALVE A or B</p> |
| <p>Configure At:<br/>MENU/SETUP/ADV/<br/>VALVES/PC#1</p>           | <p>Configure At:<br/>MENU/SETUP/ADV/<br/>REMOTES/IS4'S</p>   | <p>Configure At:<br/>MENU/SETUP/ADV/<br/>REMOTES/IS10'S</p>   |  |

## WORKSHEET FOR SHARED EQUIPMENT SYSTEMS i5, i7+3, i9+3 (Sheet 2 of 2)

| Create Custom Names At:<br>MENU/SETUP/ADV/<br>CUSTOM/EDIT                     | PROGRAMMABLE SETTINGS           |                               |          |                      |                                 |                               |      |                      |        |         | MAIN SCREEN CONFIG |   |   |   |  |
|---|---------------------------------|-------------------------------|----------|----------------------|---------------------------------|-------------------------------|------|----------------------|--------|---------|--------------------|---|---|---|--|
|   | 1/ TOTAL                        |                               | 2/ TOTAL |                      | 3/ TOTAL                        |                               | LEFT |                      | RIGHT  |         |                    |   |   |   |  |
| CIRCUIT NAME<br><small>POOL (may be renamed)<br/>SPA (may be renamed)</small> | START TIME OR<br>EGGTIMER (Y/N) | STOP TIME OR<br>EGGTIMER TIME | DAYS     | SMART START<br>(Y/N) | START TIME OR<br>EGGTIMER (Y/N) | STOP TIME OR<br>EGGTIMER TIME | DAYS | SMART START<br>(Y/N) | #1 SPA | #1 POOL | 2                  | 3 | 4 | 5 |  |
| Program At:<br>MENU/PROGRAM   |                                 |                               |          |                      |                                 |                               |      |                      |        |         |                    |   |   |   |  |
|   |                                 |                               |          |                      |                                 |                               |      |                      |        |         |                    |   |   |   |  |
|   |                                 |                               |          |                      |                                 |                               |      |                      |        |         |                    |   |   |   |  |
|   |                                 |                               |          |                      |                                 |                               |      |                      |        |         |                    |   |   |   |  |
|   |                                 |                               |          |                      |                                 |                               |      |                      |        |         |                    |   |   |   |  |
|   |                                 |                               |          |                      |                                 |                               |      |                      |        |         |                    |   |   |   |  |
|   |                                 |                               |          |                      |                                 |                               |      |                      |        |         |                    |   |   |   |  |
|   |                                 |                               |          |                      |                                 |                               |      |                      |        |         |                    |   |   |   |  |
|   |                                 |                               |          |                      |                                 |                               |      |                      |        |         |                    |   |   |   |  |
|   |                                 |                               |          |                      |                                 |                               |      |                      |        |         |                    |   |   |   |  |
|   |                                 |                               |          |                      |                                 |                               |      |                      |        |         |                    |   |   |   |  |
|   |                                 |                               |          |                      |                                 |                               |      |                      |        |         |                    |   |   |   |  |
| Configure At:<br>MENU/SETUP/ADV/<br>CIRCUIT NAMES/<br>MAIN SCREEN CONFIG      |                                 |                               |          |                      |                                 |                               |      |                      |        |         |                    |   |   |   |  |
|   |                                 |                               |          |                      |                                 |                               |      |                      |        |         |                    |   |   |   |  |
|   |                                 |                               |          |                      |                                 |                               |      |                      |        |         |                    |   |   |   |  |
|   |                                 |                               |          |                      |                                 |                               |      |                      |        |         |                    |   |   |   |  |
|   |                                 |                               |          |                      |                                 |                               |      |                      |        |         |                    |   |   |   |  |

## WORKSHEET FOR SINGLE BODY SYSTEMS i5S, i9+3S (Sheet 1 of 2)

|   |   | HARDWIRED CONNECTIONS |  |  |  |  |  |  |  |  |  | PROGRAMMABLE SETTINGS |             |                 |                   |  |  |  |  |  |  |  |  |  |
|---|---|-----------------------|--|--|--|--|--|--|--|--|--|-----------------------|-------------|-----------------|-------------------|--|--|--|--|--|--|--|--|--|
|   |   | RELAY CONNECTIONS     |  |  |  |  |  |  |  |  |  | VALVES                |             | OPT. VALVE MOD. | CIRCUIT FUNCTIONS |  |  |  |  |  |  |  |  |  |
| CIRCUIT NAME  |   |                       |  |  |  |  |  |  |  |  |  |                       |             |                 |                   |  |  |  |  |  |  |  |  |  |
| LO-TEMP (may be renamed)  |   |                       |  |  |  |  |  |  |  |  |  |                       |             |                 |                   |  |  |  |  |  |  |  |  |  |
| HI-TEMP (may be renamed)  |   |                       |  |  |  |  |  |  |  |  |  |                       |             |                 |                   |  |  |  |  |  |  |  |  |  |
| Create Custom Names At:<br><b>MENU/SETUP/ADV/<br/>CUSTOM/EDIT</b> | Assign Circuit Names At:<br><b>MENU/SETUP/ADV/<br/>AUX NAMES/DISPLAY 1-4<br/>OR FEATURE</b><br><b>NOTE:</b> HI-TEMP and LO-TEMP<br>may be renamed but they<br>always activate the circuits<br>indicated |                       |  |  |  |  |  |  |  |  |  | X                     |             | X               | FLTR PMP          |  |  |  |  |  |  |  |  |  |
|   |   |                       |  |  |  |  |  |  |  |  |  |                       |             |                 | AUX1              |  |  |  |  |  |  |  |  |  |
|   |   |                       |  |  |  |  |  |  |  |  |  |                       |             |                 | AUX2              |  |  |  |  |  |  |  |  |  |
|   |   |                       |  |  |  |  |  |  |  |  |  |                       |             |                 | AUX3              |  |  |  |  |  |  |  |  |  |
|   |   |                       |  |  |  |  |  |  |  |  |  |                       |             |                 | AUX4              |  |  |  |  |  |  |  |  |  |
|   |   |                       |  |  |  |  |  |  |  |  |  |                       |             |                 | AUX5              |  |  |  |  |  |  |  |  |  |
|   |   |                       |  |  |  |  |  |  |  |  |  |                       |             |                 | AUX6              |  |  |  |  |  |  |  |  |  |
|   |   |                       |  |  |  |  |  |  |  |  |  |                       |             |                 | AUX7              |  |  |  |  |  |  |  |  |  |
|   |   |                       |  |  |  |  |  |  |  |  |  |                       |             |                 | AUX8              |  |  |  |  |  |  |  |  |  |
|   |   |                       |  |  |  |  |  |  |  |  |  |                       |             |                 | AUX 9             |  |  |  |  |  |  |  |  |  |
|   |   |                       |  |  |  |  |  |  |  |  |  |                       |             |                 | AUX 10            |  |  |  |  |  |  |  |  |  |
|   |   |                       |  |  |  |  |  |  |  |  |  |                       | SOLAR       |                 |                   |  |  |  |  |  |  |  |  |  |
|   |   |                       |  |  |  |  |  |  |  |  |  |                       | 2 SPEED     |                 |                   |  |  |  |  |  |  |  |  |  |
|   |   |                       |  |  |  |  |  |  |  |  |  |                       | ELEC HTR    |                 |                   |  |  |  |  |  |  |  |  |  |
|   |   |                       |  |  |  |  |  |  |  |  |  |                       | VALVE A     |                 |                   |  |  |  |  |  |  |  |  |  |
|   |   |                       |  |  |  |  |  |  |  |  |  |                       | VALVE B     |                 |                   |  |  |  |  |  |  |  |  |  |
|   |   |                       |  |  |  |  |  |  |  |  |  |                       | VALVE C     |                 |                   |  |  |  |  |  |  |  |  |  |
|   |   |                       |  |  |  |  |  |  |  |  |  |                       | VALVE D     |                 |                   |  |  |  |  |  |  |  |  |  |
|   |   |                       |  |  |  |  |  |  |  |  |  |                       | VALVE E     |                 |                   |  |  |  |  |  |  |  |  |  |
|   |   |                       |  |  |  |  |  |  |  |  |  |                       | GENERIC     |                 |                   |  |  |  |  |  |  |  |  |  |
|   |   |                       |  |  |  |  |  |  |  |  |  |                       | MASTER CLNR |                 |                   |  |  |  |  |  |  |  |  |  |
|   |   |                       |  |  |  |  |  |  |  |  |  |                       | LIGHT       |                 |                   |  |  |  |  |  |  |  |  |  |
|   |   |                       |  |  |  |  |  |  |  |  |  |                       | DIMMER      |                 |                   |  |  |  |  |  |  |  |  |  |
|   |   |                       |  |  |  |  |  |  |  |  |  |                       | SAM LIGHT   |                 |                   |  |  |  |  |  |  |  |  |  |
|   |   |                       |  |  |  |  |  |  |  |  |  |                       | SAL LIGHT   |                 |                   |  |  |  |  |  |  |  |  |  |
|   |   |                       |  |  |  |  |  |  |  |  |  |                       | PHOTON GEN  |                 |                   |  |  |  |  |  |  |  |  |  |
|   |   |                       |  |  |  |  |  |  |  |  |  |                       | COLOR WHEEL |                 |                   |  |  |  |  |  |  |  |  |  |
|   |   |                       |  |  |  |  |  |  |  |  |  |                       | VALVE       |                 |                   |  |  |  |  |  |  |  |  |  |
|   |   |                       |  |  |  |  |  |  |  |  |  |                       | SPILLWAY    |                 |                   |  |  |  |  |  |  |  |  |  |
|   |   |                       |  |  |  |  |  |  |  |  |  |                       | FLOOR CLNR  |                 |                   |  |  |  |  |  |  |  |  |  |
|   |   |                       |  |  |  |  |  |  |  |  |  |                       | 1           |                 |                   |  |  |  |  |  |  |  |  |  |
|   |   |                       |  |  |  |  |  |  |  |  |  |                       | 2           |                 |                   |  |  |  |  |  |  |  |  |  |
|   |   |                       |  |  |  |  |  |  |  |  |  |                       | 3           |                 |                   |  |  |  |  |  |  |  |  |  |
|   |   |                       |  |  |  |  |  |  |  |  |  |                       | 4           |                 |                   |  |  |  |  |  |  |  |  |  |
|   |   |                       |  |  |  |  |  |  |  |  |  |                       | 1           |                 |                   |  |  |  |  |  |  |  |  |  |
|   |   |                       |  |  |  |  |  |  |  |  |  |                       | 2           |                 |                   |  |  |  |  |  |  |  |  |  |
|   |   |                       |  |  |  |  |  |  |  |  |  |                       | 3           |                 |                   |  |  |  |  |  |  |  |  |  |
|   |   |                       |  |  |  |  |  |  |  |  |  |                       | 4           |                 |                   |  |  |  |  |  |  |  |  |  |
|   |   |                       |  |  |  |  |  |  |  |  |  |                       | 1           |                 |                   |  |  |  |  |  |  |  |  |  |
|   |   |                       |  |  |  |  |  |  |  |  |  |                       | 2           |                 |                   |  |  |  |  |  |  |  |  |  |
|   |   |                       |  |  |  |  |  |  |  |  |  |                       | 3           |                 |                   |  |  |  |  |  |  |  |  |  |
|   |   |                       |  |  |  |  |  |  |  |  |  |                       | 4           |                 |                   |  |  |  |  |  |  |  |  |  |
|   |   |                       |  |  |  |  |  |  |  |  |  |                       | 1           |                 |                   |  |  |  |  |  |  |  |  |  |
|   |   |                       |  |  |  |  |  |  |  |  |  |                       | 2           |                 |                   |  |  |  |  |  |  |  |  |  |
|   |   |                       |  |  |  |  |  |  |  |  |  |                       | 3           |                 |                   |  |  |  |  |  |  |  |  |  |
|   |   |                       |  |  |  |  |  |  |  |  |  |                       | 4           |                 |                   |  |  |  |  |  |  |  |  |  |
|   |   |                       |  |  |  |  |  |  |  |  |  |                       | 5           |                 |                   |  |  |  |  |  |  |  |  |  |
|   |   |                       |  |  |  |  |  |  |  |  |  |                       | 1           |                 |                   |  |  |  |  |  |  |  |  |  |
|   |   |                       |  |  |  |  |  |  |  |  |  |                       | 2           |                 |                   |  |  |  |  |  |  |  |  |  |
|   |   |                       |  |  |  |  |  |  |  |  |  |                       | 3           |                 |                   |  |  |  |  |  |  |  |  |  |
|   |   |                       |  |  |  |  |  |  |  |  |  |                       | 4           |                 |                   |  |  |  |  |  |  |  |  |  |
|   |   |                       |  |  |  |  |  |  |  |  |  |                       | 5           |                 |                   |  |  |  |  |  |  |  |  |  |

These connections correspond to Control Panel  
 Display 1 for the mother system,  
 Display 2 for the 2nd Load Center,  
 Display 3 for the 3rd Load Center,  
 Display 4 for the 4th Load Center

## WORKSHEET FOR SINGLE BODY SYSTEMS i5S, i9+3S (Sheet 2 of 2)

| Create Custom Names At:<br>MENU/SETUP/ADV/<br>CUSTOM/EDIT                | CIRCUIT NAME                |                             |                                 |  |  |                               |  |  |      |  |  |                   |  |  |          |  |  |  |
|--|-----------------------------|-----------------------------|---------------------------------|--|--|-------------------------------|--|--|------|--|--|-------------------|--|--|----------|--|--|--|
|  | LO-TEMP<br>(may be renamed) | HI-TEMP<br>(may be renamed) | START TIME OR<br>EGGTIMER (Y/N) |  |  | STOP TIME OR<br>EGGTIMER TIME |  |  | DAYS |  |  | SMART START (Y/N) |  |  | 1/ TOTAL |  |  |  |
| Program At:<br>MENU/PROGRAM  |                             |                             | START TIME OR<br>EGGTIMER (Y/N) |  |  | STOP TIME OR<br>EGGTIMER TIME |  |  | DAYS |  |  | SMART START (Y/N) |  |  | 2/ TOTAL |  |  |  |
|  |                             |                             | START TIME OR<br>EGGTIMER (Y/N) |  |  | STOP TIME OR<br>EGGTIMER TIME |  |  | DAYS |  |  | SMART START (Y/N) |  |  | 3/ TOTAL |  |  |  |
|  |                             |                             | START TIME OR<br>EGGTIMER (Y/N) |  |  | STOP TIME OR<br>EGGTIMER TIME |  |  | DAYS |  |  | SMART START (Y/N) |  |  |          |  |  |  |
|  |                             |                             | START TIME OR<br>EGGTIMER (Y/N) |  |  | STOP TIME OR<br>EGGTIMER TIME |  |  | DAYS |  |  | SMART START (Y/N) |  |  |          |  |  |  |
|  |                             |                             | START TIME OR<br>EGGTIMER (Y/N) |  |  | STOP TIME OR<br>EGGTIMER TIME |  |  | DAYS |  |  | SMART START (Y/N) |  |  |          |  |  |  |
|  |                             |                             | START TIME OR<br>EGGTIMER (Y/N) |  |  | STOP TIME OR<br>EGGTIMER TIME |  |  | DAYS |  |  | SMART START (Y/N) |  |  |          |  |  |  |
|  |                             |                             | START TIME OR<br>EGGTIMER (Y/N) |  |  | STOP TIME OR<br>EGGTIMER TIME |  |  | DAYS |  |  | SMART START (Y/N) |  |  |          |  |  |  |
|  |                             |                             | START TIME OR<br>EGGTIMER (Y/N) |  |  | STOP TIME OR<br>EGGTIMER TIME |  |  | DAYS |  |  | SMART START (Y/N) |  |  |          |  |  |  |
|  |                             |                             | START TIME OR<br>EGGTIMER (Y/N) |  |  | STOP TIME OR<br>EGGTIMER TIME |  |  | DAYS |  |  | SMART START (Y/N) |  |  |          |  |  |  |
|  |                             |                             | START TIME OR<br>EGGTIMER (Y/N) |  |  | STOP TIME OR<br>EGGTIMER TIME |  |  | DAYS |  |  | SMART START (Y/N) |  |  |          |  |  |  |
|  |                             |                             | START TIME OR<br>EGGTIMER (Y/N) |  |  | STOP TIME OR<br>EGGTIMER TIME |  |  | DAYS |  |  | SMART START (Y/N) |  |  |          |  |  |  |
|  |                             |                             | START TIME OR<br>EGGTIMER (Y/N) |  |  | STOP TIME OR<br>EGGTIMER TIME |  |  | DAYS |  |  | SMART START (Y/N) |  |  |          |  |  |  |
| Configure At:<br>MENU/SETUP/ADV/ CIRCUIT<br>NAMES/<br>MAIN SCREEN CONFIG |                             |                             |                                 |  |  |                               |  |  |      |  |  |                   |  |  |          |  |  |  |
|  |                             |                             |                                 |  |  |                               |  |  |      |  |  |                   |  |  |          |  |  |  |
|  |                             |                             |                                 |  |  |                               |  |  |      |  |  |                   |  |  |          |  |  |  |
|  |                             |                             |                                 |  |  |                               |  |  |      |  |  |                   |  |  |          |  |  |  |
|  |                             |                             |                                 |  |  |                               |  |  |      |  |  |                   |  |  |          |  |  |  |
|  |                             |                             |                                 |  |  |                               |  |  |      |  |  |                   |  |  |          |  |  |  |
|  |                             |                             |                                 |  |  |                               |  |  |      |  |  |                   |  |  |          |  |  |  |
|  |                             |                             |                                 |  |  |                               |  |  |      |  |  |                   |  |  |          |  |  |  |
|  |                             |                             |                                 |  |  |                               |  |  |      |  |  |                   |  |  |          |  |  |  |
|  |                             |                             |                                 |  |  |                               |  |  |      |  |  |                   |  |  |          |  |  |  |

## WORKSHEET FOR DUAL EQUIPMENT SYSTEMS i10+3D (Sheet 1 of 2)

| HARDWIRED CONNECTIONS   |                       | PROGRAMMABLE SETTINGS |             |               |
|---|-----------------------|-----------------------|-------------|---------------|
| RELAY CONNECTIONS   |                       | SPA-SIDE REMOTES      |             |               |
| <p>Create Custom Names At:<br/><b>MENU/SETUP/ADV/<br/>CUSTOMEDIT</b></p>  | POOL (may be renamed) | X                     | SPA PUMP    |               |
|   | SPA (may be renamed)  | X                     | POOL PUMP   |               |
|   |                       |                       |             | AUX1          |
|   |                       |                       |             | AUX2          |
|   |                       |                       |             | AUX3          |
|   |                       |                       |             | AUX4          |
|   |                       |                       |             | AUX5          |
|   |                       |                       |             | AUX6          |
|   |                       |                       |             | AUX7          |
|   |                       |                       |             | AUX8          |
|   |                       |                       |             | AUX 9         |
|   |                       |                       |             | AUX 10        |
|   |                       |                       |             | POOL SOLAR    |
|   |                       |                       |             | POOL 2 SPD    |
|   |                       |                       |             | POOL ELEC HTR |
| <p>Assign Circuit Names At:<br/><b>MENU/SETUP/ADV/<br/>AUX NAMES/DISPLAY 1-4<br/>OR FEATURE</b><br/><b>NOTE:</b> POOL and SPA may be renamed but they always activate the circuits indicated</p>  |                       |                       | SPA SOLAR   |               |
|   |                       |                       |             | SPA 2 SPD     |
|   |                       |                       |             | SPA ELEC HTR  |
|   |                       |                       |             | VALVE A       |
|   |                       |                       |             | VALVE B       |
|   |                       |                       |             | VALVE C       |
|   |                       |                       |             | VALVE D       |
|   |                       |                       |             | VALVE E       |
|   |                       |                       |             | GENERIC       |
|   |                       |                       |             | MASTER CLNR   |
|   |                       |                       |             | LIGHT         |
|   |                       |                       |             | DIMMER        |
|   |                       |                       |             | SAM LIGHT     |
|   |                       |                       |             | SAL LIGHT     |
|   |                       |                       |             | PHOTON GEN    |
|   |                       |                       | COLOR WHEEL |               |
|   |                       |                       | VALVE       |               |
|   |                       |                       | SPILLWAY    |               |
|   |                       |                       | FLOOR CLNR  |               |
| <p>Configure At:<br/><b>MENU/SETUP/EQUIP</b><br/><b>NOTE:</b> If SOLAR is checked also check VALVE A, unless SOLAR is a Heat Pump</p>   |                       |                       | 1           |               |
|   |                       |                       |             | 2             |
|   |                       |                       |             | 3             |
|   |                       |                       |             | 4             |
|   |                       |                       |             | 1             |
|   |                       |                       |             | 2             |
|   |                       |                       |             | 3             |
|   |                       |                       |             | 4             |
|   |                       |                       |             | 1             |
|   |                       |                       |             | 2             |
|   |                       |                       |             | 3             |
|   |                       |                       |             | 4             |
|   |                       |                       |             | 1             |
|   |                       |                       |             | 2             |
|   |                       |                       |             | 3             |
|   |                       |                       | 4           |               |
| <p>Configure At:<br/><b>MENU/SETUP/ADV/<br/>VALVES/PC#1</b></p>   |                       |                       | 1           |               |
|   |                       |                       |             | 2             |
|   |                       |                       |             | 3             |
|   |                       |                       |             | 4             |
|   |                       |                       |             | 1             |
|   |                       |                       |             | 2             |
|   |                       |                       |             | 3             |
|   |                       |                       |             | 4             |
|   |                       |                       |             | 1             |
|   |                       |                       |             | 2             |
|   |                       |                       |             | 3             |
|   |                       |                       |             | 4             |
|   |                       |                       |             | 1             |
|   |                       |                       |             | 2             |
|   |                       |                       |             | 3             |
|   |                       |                       | 4           |               |
| <p>Assign Circuit Functions At:<br/><b>MENU/SETUP/ADV/FUNC/<br/>"Circuit Name"</b><br/><b>NOTE:</b> Use DISPLAY to toggle through Display 1-4 and Feature Circuits<br/><b>NOTE:</b> If MASTER CLNR is checked FLTR PMP will also turn on; If DIMMER is checked also assign an AUX; If SPILLWAY is checked, RETURN VLV operates; If FLOOR CLNR is checked also assign VALVE A or B</p> |                       |                       | 1           |               |
|   |                       |                       |             | 2             |
|   |                       |                       |             | 3             |
|   |                       |                       |             | 4             |
|   |                       |                       |             | 1             |
|   |                       |                       |             | 2             |
|   |                       |                       |             | 3             |
|   |                       |                       |             | 4             |
|   |                       |                       |             | 1             |
|   |                       |                       |             | 2             |
|   |                       |                       |             | 3             |
|   |                       |                       |             | 4             |
|   |                       |                       |             | 1             |
|   |                       |                       |             | 2             |
|   |                       |                       |             | 3             |
|   |                       |                       | 4           |               |
| <p>Configure At:<br/><b>MENU/SETUP/ADV/<br/>REMOTES/IS4'S</b></p>   |                       |                       | 1           |               |
|   |                       |                       |             | 2             |
|   |                       |                       |             | 3             |
|   |                       |                       |             | 4             |
|   |                       |                       |             | 1             |
|   |                       |                       |             | 2             |
|   |                       |                       |             | 3             |
|   |                       |                       |             | 4             |
|   |                       |                       |             | 1             |
|   |                       |                       |             | 2             |
|   |                       |                       |             | 3             |
|   |                       |                       |             | 4             |
|   |                       |                       |             | 1             |
|   |                       |                       |             | 2             |
|   |                       |                       |             | 3             |
|   |                       |                       | 4           |               |
| <p>Configure At:<br/><b>MENU/SETUP/ADV/<br/>REMOTES/IS10'S</b></p>  |                       |                       | 1           |               |
|   |                       |                       |             | 2             |
|   |                       |                       |             | 3             |
|   |                       |                       |             | 4             |
|   |                       |                       |             | 1             |
|   |                       |                       |             | 2             |
|   |                       |                       |             | 3             |
|   |                       |                       |             | 4             |
|   |                       |                       |             | 1             |
|   |                       |                       |             | 2             |
|   |                       |                       |             | 3             |
|   |                       |                       |             | 4             |
|   |                       |                       |             | 1             |
|   |                       |                       |             | 2             |
|   |                       |                       |             | 3             |
|   |                       |                       | 4           |               |





## The Main Outdoor Control Panel

The main Outdoor Control Panel consists of the Personality board mounted onto the motherboard. The Outdoor Control Panel is housed in the Load Center or Power Center. It includes, control buttons for pumps, filters, and heater, red status lights, and a Reset button. The Personality board defines the type of equipment installed. The Outdoor Control Panel can be used to override the Indoor Control Panel functions for pool service and for equipment set up. The Outdoor Control Panel can be folded downward to access the Personality board.

**Note:** Pressing System Control buttons at any of the Outdoor Control Panels, will affect the entire system.

**CAUTION:** Be sure the High Voltage Cover Panel is in place over the bottom edge of the control panel. DO NOT OPERATE ANY OF THESE CONTROLS BEFORE READING THESE INSTRUCTIONS.

## Shared Equipment Systems i5, i7+3, i9+3

### System Control

Three LED indicator lights on the far left indicate the current mode of operation.

By pressing the button adjacent to these lights you may toggle through the various modes.

**AUTO** mode enables all remote controls (Indoor Control Panel, spa-side remotes, radio frequency remotes, etc. Spa-side remotes may still be disabled by the Indoor Control Panel or MobileTouch).

**SERVICE** mode allows auxiliaries to be operated directly from the Outdoor Control Panel while disabling all other remotes.

### Low Voltage Circuit Breakers

To the far right are 3 Amp circuit breakers to protect low voltage circuits.

Check these as part of any troubleshooting activity.

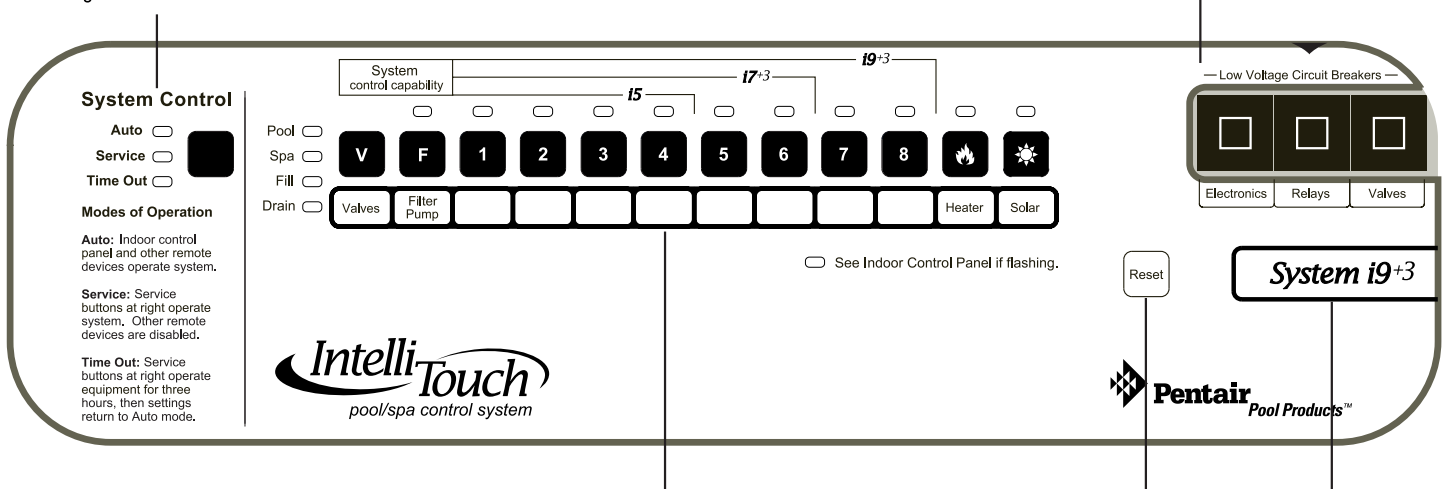

### System Control Capability Buttons

In **SERVICE** mode, hitting any of the horizontal buttons will activate the corresponding circuit. Some of the buttons are specially dedicated to certain functions described below.

**V:** This button will turn valves so that only the pool water is circulated through the system, only the spa water is circulated through the system, the spa will be filled with pool water, or the spa will be emptied of water into the pool. When the system is set to **AUTO** mode the actuators will turn to Pool Mode. **NOTE:** a spillway effect may be simulated by setting valves from the Indoor Control Panel to Fill. Be sure a spillway has been built into the spa.

**F:** This button will activate the filter pump. If your pump has been wired for two speed operation, the first time this is pressed will put the pump in LOW speed and pressing again will put it in HIGH speed. A third press will turn it off. This button also has further capability during system set-up and configuration.

**Heater (Flame):** This will automatically turn the heater on. **NOTE:** This does not activate a pump. Heaters should not be activated without running a pump and normally will not run if water flow is not detected. The heater will continue heating the water until the heater's high limit temperature sensor is triggered (approximately 106° F) or the T-Stat setting.

**Solar (Sun):** Two things happen when this is activated. (1) The solar relay is turned on to activate a booster pump if installed. (2) Valves will be turned to divert water through solar heating panels **ONLY IF** the system has been told the solar heating is present through the Indoor Control Panel.

### System Identification Label:

System i5, System i7+3,  
System i9+3: Mother System

### Reset

Pressing this button will restart the Outdoor Control Panel. Wait until the System Control indicator light has settled on Auto mode and the Valve indicator light has settled on Pool mode before resuming normal operation. **DO NOT** press any other buttons at this time or you may trigger the Advanced Set-up and Configuration functions.

## Single Body Systems Model i5S, i9+3S

Operation same as i5, i9+3 except no valve controls.

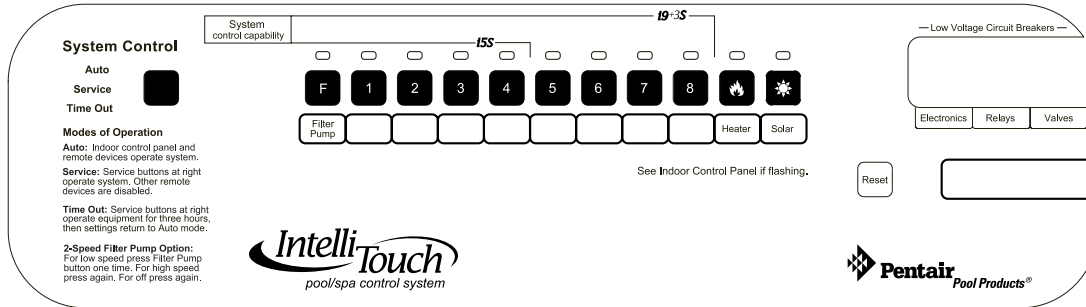

## Dual Body Dual Equipment System Model i10+3D

Operation same as i9+3 except S and P buttons operate independent filter pumps and the Heater and Solar buttons operate independent heating systems and no valve controls.

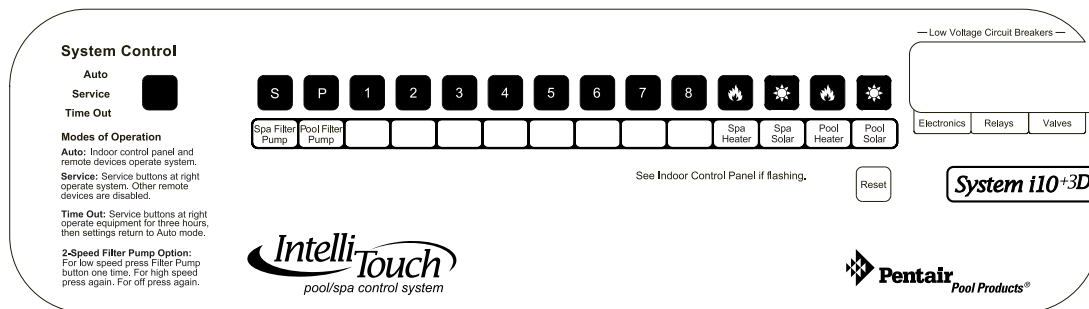

## Expansion Centers Model i5x, i10x

Expansion Centers provide additional valve and auxiliary circuits. They are designed to operate with base systems: i9+3, i9+3S, i10+3D. Auxiliary Control Capability Buttons operate the same way as all other system Control Capability Buttons.

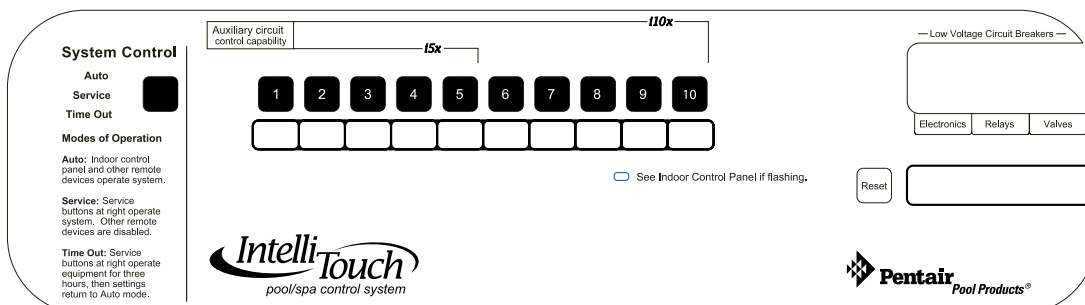

## Erasing Outdoor Control Panel Memory (Factory Default)

The Outdoor Control Panel programmed memory can be erased and returned to the factory default settings. System information such as feature circuit configuration, operation and display is retained at the main Load Center Outdoor Control Panel and all Indoor Control Panels and MobileTouch controllers. If the memory is erased in the main Outdoor Control Panel (located in the Load Center or Power Center), system information retained in the Indoor Control Panel or MobileTouch is automatically downloaded. This feature is important in case of accidental memory loss and to ease board replacement. If there are multiple Expansion Center, iS10 Spa-Side remotes, or Indoor Control Panels, each one of the controllers will need to be manually enabled (see page 54 for details). For instructions about erasing system memory from both the Outdoor Control Panel and Indoor Control Panel, refer to “Erasing the System Memory,” page 65.

To reset to the factory default settings:

1. On the Outdoor Control Panel, press the **RESET** button.
2. The three red System Control LEDs are lit for about ten seconds.
3. While the red LEDs are lit, press one of the following buttons
  - For models i5, i7+3, i9+3, i5S, i9+3S, and i10+3D, press **button 5**.
  - For models i5x, i10x, press **button 7**.
4. The System Control LEDs will switch off then on completing a normal system restart. Wait until the system has returned to “AUTO” and “POOL” modes before resuming operation.

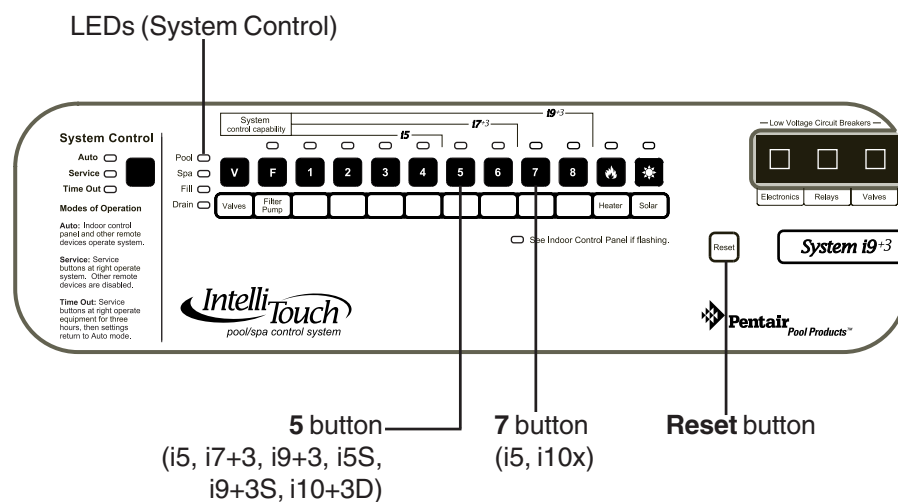

**Main Outdoor Control Panel (Located in the Load Center or Power Center)**



## Troubleshooting

## System Start-Up

The following information describes a basic system start-up procedure. Before switching on the power to the IntelliTouch Load Center or Power Center, first check the following:

### Check Electronics

Check that the following plugs are seated correctly on the Personality board. For connector locations, refer to the System Wiring Diagrams on page 88 and 89.

- Relay connectors - **FLTR PUMP - AUX1 - AUX8**
- Temperature sensors connectors - **WATER, SOLAR, AIR**
- Transformer wire harness - **J2**
- Heater control connector - **ELEC HTR or screw terminals**

### System Test

The following describes how to test the Outdoor Control Panel to activate the heater, valves and pumps. This test assumes that all system equipment has been properly installed and connected to the Load Center and Power Center.

Testing Valve Actuators and Pumps:

Use the following steps to test the valve actuators (CVA24T - P/N 263045) for proper rotation. For Outdoor Control Panel System i5, i7+3, i9+3 (shared equipment).

To test the valve actuators and pump:

1. Power up the Load Center or Power Center.
2. Press the **SYSTEM CONTROL** button on the Outdoor Control Panel until the **SERVICE** light is on. .
3. Press the **V (Valve)** button to select **POOL**.
4. Press the **F (Filter Pump)** button to activate the filter pump. Water will be removed from the pool and returned to the pool. The bypass valve will allow some water to fall from the spa back to the pool.
5. Set both valve actuators (CVA24T - P/N 263045) for suction and return. Use the toggle switch on the rear of the CVA-24 to withdraw and return water from the pool.

*Note:* With the filter pump operating, if water is not being removed and returned to the pool, it may be necessary to check the plugs on the Personality board and the toggle switches on the valve actuators.

### Testing the Auxiliary Relays

Affix the auxiliary relay labels to the appropriate buttons on the Outdoor Control Panel. If necessary, write the function on the control panel.

## Troubleshooting

This section provides information to help you resolve any problems that may occur during installing or using the IntelliTouch system. If by following the recommended actions you are still unable to resolve the problems please contact Technical Support, see page vi.

## Frequently Asked Questions (FAQ)

### What does the '+3' on some of the systems mean?

The first number of a "System Personality" indicates the number of high voltage (auxiliary) circuits available including the filter pump. The '+3' indicates the capability of operating additional equipment without using up high voltage circuits. Typically this refers to spillway functionality, valve control (see page 44), and feature circuits (see page 56).

### How Do I Setup/Configure/Program the 2-Speed Pump?

Two-speed pumps operate using two relays and one or more circuits with the IntelliTouch system. The first relay turns the pump on or off. Assuming this is the filter pump and depending on the system personality, this circuit is controlled by the Pool, Spa, high temp, or low temp circuits or any other circuit that may be tied to the filter pump (such as circuits with freeze protection, etc.). The second relay turns the pump from low speed to high speed. The default condition is low speed, but up to 10 circuits may be assigned to trigger the pump to high speed. Note: These 10 circuits do NOT turn the pump on.

To configure a two-speed pump relay, refer to "Setting Up a 2-Speed Pump," page 50. For relay location and wiring, see page 88 and 89. The 2-Speed pump relay is plugged into the 2-SPD output on the Personality board. A circuits must be assigned to trigger from low to high speed, see page 50 for details.

### Can I turn the Heater On and Change the temperature from the Spa?

The heater may be turned on from the spa using one of two hardwired Spa-Side remote (iS4 or iS10) or by wireless remote controls (MobileTouch or QuickTouch). To learn more about these remotes and controllers, see page 12, 13, 14, and 16. Only the iS10 or wireless controllers can change the temperature from the spa location.

### How do I get Solar to switch on?

The system must first be told that solar heat is installed. Go to the Solar equipment screen (**Menu > Setup > Equipment > Solar**) and press the **YES** button to tell the system solar is present. Note: Do not set solar as a heat pump. Then the heating method must be selected for each body of water. Many options are available through the Heat screen. For instructions on how to select the heating method see page 49.

## What are Color Swim and Color Set?

**Color Set:** Allows any combination of up to 12 *SAm*, *SAL*, and/or *FIBERworks* lighting circuits to be preset to specific colors, such as red, white, and blue for the Fourth of July or red and green for Christmas.

**Color Swim:** Allows any combination of up to twelve *SAm*, *SAL*, and/or *FIBERworks* lighting circuits to be preset to transition through colors in sequence, giving the appearance of the colors swimming across the water. The delay in sequencing each light can be adjusted to customize the display for your pool. For more information see “Setting Up Lighting Options,” page 45.

## How do I get *SAm/SAL/PG2000* to Synchronize?

There are many ways to configure color changing lights to synchronize on the same colors. The first step is to assign all color changing light circuits a circuit function such as *SAm*, *SAL*, Photon Generator, or Color Wheel. Refer to “Assigning Circuit Functions,” page 43.

To manually synchronize the lights, use the **Sync** button on the Lights screen. Refer to page 10 for details about how to get the circuits to appear on the **Lights** Screen.

Light circuits may be controlled to switch on at a particular time and synchronize automatically. This may be done by using the **Smart Start** functionality in the Program Screen. See page 16 for programming details.

## Can I copy a standard configuration to all the systems I install?

Yes you can but only if you maintain a standard system configuration on a system in your headquarters. An Indoor Control Panel with a properly wired four conductor patch cable may be used to accomplish this.

 **CAUTION** - Do NOT use the Service Panel. This accessory auto erases every time power is removed. It is for on-site work only.

1. Plug the Indoor Control Panel into a COM port on the Personality board of dedicated system at headquarters.
2. One of several things may happen at this point:
  - The Indoor Control Panel may automatically download the system configuration if its own memory was erased.
  - You may be prompted to update system personality, see page 65.
  - You may be prompted to select Indoor or Outdoor memory. Always Select Outdoor or you will write over your dedicated set up.
  - You may have to force a download to the system.
3. This same controller may then be taken to the job-site to configure the system. Switch off the system power. Open Load Center or Power Center front door, remove the two retaining screws and fold down the Outdoor Control Panel.
4. Plug in the Indoor Control Panel to one of the COM ports from headquarters.

 **CAUTION** - Be sure to check that the wiring is matching both ends before turning system power back on. Crossed wiring may permanently damage the system.

5. The procedure is identical to Step 2 above. Plug into the COM port on the Personality board in the Load Center or Power Center. Again, several different things may happen. Check all the relevant sections to avoid any problems.



## Fixing mismatched system personalities

There are many possibilities that may cause an Indoor Control Panel or MobileTouch to have a model personality (i9+3, i10+3D, etc.) that is different from the system personality. Such occasions include but are not limited to:

1. Controller is added or replaced. Accessory and replacement controllers leave the factory identified as i9+3 system personalities.
2. Controller memory is erased while unplugged from the system.
3. System personality was changed.

This is a minor problem and you may see a mismatched system personality screen. Press NEXT to update the controller to match the system personality. If you do not want to update the controller (most likely because you are service person using the controller for another purpose) then press IGNORE.

## Indoor Control Panel and Outdoor Control Panel Connection Problem

System information relating to circuit configuration, operation and display is retained at the main Load Center Outdoor Control Panel and all Indoor Control Panels and MobileTouch. System information is automatically downloads from programmed components to non-programmed components in case of accidental memory loss and to ease board replacement.

If for some reason the controller and outdoor control panel both have user settings that conflict with each other then this must be reconciled. Such occasions include but are not limited to:

1. The MobileTouch wireless controller made changes while the system power was down.
2. A service company made a special upgrade and installed it on an existing system.

If the Service Personnel screen appears, choose Indoor to use the controller settings and Outdoor to use the Outdoor Control Panel settings. Refer to page 65 for more information.

## MobileTouch Temperature Readout Not Accurate (20 to 30 Degrees off)

**Problem:** If the MobileTouch wireless controller LCD temperature readout displays an inaccurate reading, it may be due to wireless signal interference. In this case, the air temperature readout can be correct.

**Description:** Temperature sensor cables are picking up signal interference.

**Solution:** To prevent signal transmission interference, ensure that the temperature sensor cables that connect the sensor to the Load Center are not routed near a Florescent lighting fixture (within six inches).

## System Problem Diagnosis

Use the following information to resolve system problems.

Problem: The system works in Service Mode, but Indoor Control Panel fails to operate.

| Symptom  | Possible Cause  | Solution   |
|--|---|--|
| Indoor Control Panel has no power - (screen, blank , no LEDs, buttons not working.   | Bad wiring run from Outdoor Control Panel/Personality board in the Load Center or Power Center  | Check wiring, and screw terminal connections. Ensure no wires are broken or shorted. Create/Use a short test cable and connect the indoor panel directly to the power center. Correct the wiring order between all units. In some cases this may cause permanent damage. If this occurs contact Technical Support for replacement PCBs. This is most effectively determined by using a spare Indoor controller or Service man's panel. Contact Technical Support for replacement PCB |
|  | Wired incorrectly (wires not in correct order)  | Correct the wiring order between all units. In some cases this may cause permanent damage. If this occurs contact tech support for replacement PCBs.   |
|  | Defective Indoor Control Panel  | This is most effectively determined by using a spare Indoor controller or service man's panel. Contact tech support for replacement PCB  |
| Indoor panel Lights up, but fails to operate correctly. The unit will not turn equipment on/off, or may turn some items on, but not off and may not LEDs near buttons on indoor panel. | Defective Cable/wiring  | Verify cable and insure no connections are broken. In some cases a wire is broken under the insulation. The two center wires of the four conductor cable are suspect (Green and Yellow)  |
|  | This is most effectively determined by using a spare Indoor controller or service man's panel. Contact tech support for replacement PCB | This is most effectively determined by using a spare Indoor controller or service man's panel. Contact tech support for replacement PCB. In systems with multiple control panels/IS10 determine fault - call Technical Support   |
| Indoor Control Panel not responding.   | Incorrect address.  | Indoor control Panel has a different address than the Outdoor control Panel. Press RESET then AUX 1 button. Go to the Indoor Control Panel and lock on ADDRESS.  |

Problem: Indoor and Outdoor Control Panels work, but iS4 fails to operate.

| 7Symptom  | Possible Cause   | Solution   |
|---|--|--|
| iS4 Spa Side fails to operate equipment .                             | Spa Side Control is Disabled by main panel.                                  | Using the indoor panel or a service man's panel. Press 'MENU' and insure the selection reads "SPA SIDE REMOTE ENABLED". If it reads "SPA SIDE REMOTE DISABLED" press the button beside the option to toggle the selection. |
|   | Incorrect configuration or circuit to switch assignment or defective wiring. | Verify iS4 setup. Press 'MENU/SETUP/ADVANCED/SPA, RF, & PHONE REMOTES'Select 'CONFIGURE iS4's'Insure the iS4 in question has the expected circuit assignments, and is not assigned to unused circuits.                     |
|   | Defective iS4  | Replace defective iS4  |
| iS4 fails to operate only some of the switches, but others work fine. | Defective wiring on one or more iS4 leads                                    | Verify wiring as described above   |
|   | Incorrect configuration or circuit to switch assignment.                     | Verify configuration as described above  |
|   | Defective iS4  | Test and verify iS4 with a Volt-Ohm meter. Replace defective iS4. Contact Technnical Support. if unit is still bad.  |

Problem: Indoor and Outdoor Control Panels work, but iS10 fails to operate.

| Symptom  | Possible Cause  | Solution  |
|--|---|---|
| iS10 Spa Side fails to operate equipment .                             | Spa Side Control is Disabled from the main control panel. | Using the indoor panel or a serviceman's panel. Press 'MENU' and ensure the selection reads "SPA SIDE REMOTE ENABLED". If it reads "SPA SIDE REMOTE DISABLED" press the button beside the option to toggle the selection. |
|  | Defective Wiring  | Verify iS10 setup. Press 'MENU/SETUP/ADVANCED/SPA, RF, & PHONE REMOTES>Select 'CONFIGURE iS10's' . Ensure the iS10 in question has the expected circuit assignments, and is not assigned to unused circuits.              |
|  | Incorrect configuration or circuit to switch assignment.  | Verify iS10 setup. Press 'MENU/SETUP/ADVANCED/SPA, RF, & PHONE REMOTES>Select 'CONFIGURE iS10's' Ensure the iS10 in question has the expected circuit assignments, and is not assigned to unused circuits.                |
|  | iS10 is not correctly enabled                             | See page 55 to manually enable the iS10.  |
|  | Defective iS10  | Replace defective iS10. Contact Technical Support.  |
| iS10 fails to operate only some of the switches, but others work fine. | Defective wiring on one or more iS10 leads                | Verify wiring as described above. This is rare, and normally the only wire lead that can cause this would be the 'Green' wire. Verify Connection.   |
|  | Incorrect configuration or circuit to switch assignment.  | Verify configuration as described above   |
|  | Defective iS10  | Test and verify iS10 with a Volt-Ohm meter. Replace defective iS10. Contact Technical Support. if unit is still bad.  |

Problem: The Mobile Control Panel will not work, or will not work dependably.

| Symptom   | Possible Cause   | Solution  |
|---|--|---|
| The MobileTouch fails to operate. It does not turn on or light up.  | Battery is not charged or unit is not plugged in.  | Attached the AC recharger into the MobileTouch and plug into a wall outlet.   |
|   | Defective MobileTouch.   | Replace unit. Contact Technical Support.  |
| The MobileTouch fails to operate.   | The unit has not been enabled correctly.   | See page 31 to manually enable the MobileTouch.   |
|   | Defective Wiring - The Transceiver attached to the Load Center or Power Center is not correctly wired. | Verify Wiring, and wiring order. Check for broken wires and loose connections.  |
|   | Defective Transceiver at the Load Center or Power Center.  | Verify that the two LEDs on the Transceiver are active as expected. The LED marked POWER should always be lit. The LED marked LINK ACTIVITY should flash approx. every two seconds or whenever there is communication (such as when you press a button on the MobileTouch). |
|   | Defective MobileTouch.   | Replace unit. Contact Technical Support.  |
| The MobileTouch fails to operate dependably.  | Defective Wiring - The Transceiver attached to the Load Center or Power Center is not correctly wired. | This is rare, and normal, only the green wire would cause this problem. Verify Connection.  |
| The MobileTouch has very poor operating range   | Less than optimum location of the Transceiver connected to the Load Center or Power Center.            | Relocate the transceiver to allow a less obstructed path between the MobileTouch and the Transceiver.   |
| The MobileTouch range is no more than 30 feet even with clear line of sight operation to the Transceiver. | Defective unit or Transceiver. Likely defective or broken antenna or internal antenna connection.      | Contact Technical Support.  |

Problem: The Quick Touch remote will not work, or will not work dependably.

| Symptom  | Possible Cause   | Solution   |
|--|--|--|
| POWER LED does not light on the Receiver PCB   | IntelliTouch Load Center or Power Center does not have power.  | Ensure power is being supplied and that the power center operates correctly without the receiver installed.  |
|  | Defective cable or connection to the Load Center or Power Center.                                      | Verify the function of the board using known good cable set. Check all wiring.   |
|  | Defective Receiver board.  | Contact Technical Support.   |
| COMM LINK LED does not light or blink. In normal operation LED will blink at least every 2 seconds | Defective cable or connection to the Load Center or Power Center.                                      | Verify the function of the board using known good cable set.   |
|  | Defective receiver board.  | Replace receiver board.  |
| Address switches are incorrectly configured  | Verify that the address switches on the transmitter and handheld receiver board are correct and match. | Transmitter battery has failed.  |
|  | Replace Transmitter battery  | Defective Transmitter or Receiver  |
|  | Contact Technical Support.   |  |
| Unit functions, but some circuits do not work, or operate the incorrect circuit                    | QuickTouch configuration is incorrect.   | Verify QT setup. Press 'MENU/SETUP/ADVANCED/SPA, RF, & PHONE REMOTES' Select 'CONFIGURE QUICKTOUCH' Ensure the QuickTouch has the expected circuit assignments, and is not assigned to unused circuits |
| Unit fails to operate, or fails operate dependably at range  | Undue electrical noise   | Relocate the receiver away from equipment such as blower motors.   |
|  | Too many obstructions between the transmitter and receiver.  | Relocate receiver.   |
|  | Receiver unit is too near the ground.  | Relocate the receiver to maximize the distance between the receiver antenna and the ground.  |

Problem: The Quick Touch remote will not work, or will not work dependably (Continued).

| Symptom  | Possible Cause  | Solution  |
|--|---|---|
| Unit seems to turn on or off circuits without the user / transmitter   | A near by home is operating a similar wireless unit   | Select a an alternate address code for the transmitter and receiver. I.e. change the switches on both boards to an alternate, but matching setting.   |
| Unit dependably turns equipment ON, but once equipment is running it does not dependably turn equipment OFF, or range is greatly reduced when equipment is running | Undue electrical noise is being produced by one or more pieces of equipment in close proximity to the receiver. | Relocate the Receiver away from equipment such as blower motorsRelocate the Receiver in a location that provides fewer obstructions to the area the user commonly operates the transmitter. |
| Unit operates, but has greatly reduced range compared to prior function  | Transmitter Battery is failing  | Replace Transmitter battery   |



**WARNING**

**PREVENT ELECTROCUTION**  
INSTALL AT LEAST 5 FEET FROM INSIDE WALL OF SPA OR POOL

**DISCONNECT ALL CONNECTIONS BEFORE SERVICING THIS UNIT. THIS APPLIANCE HAS UP TO 11 SUPPLY CONNECTIONS.**

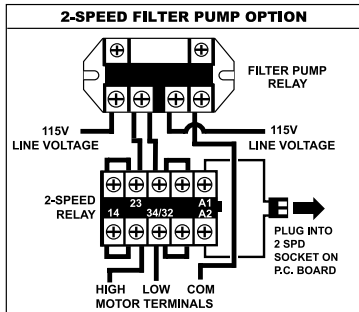
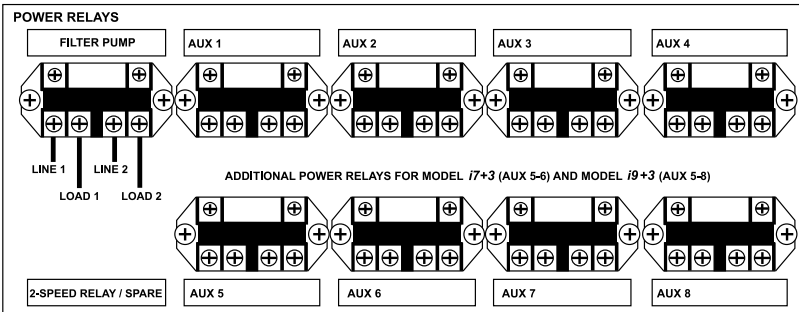
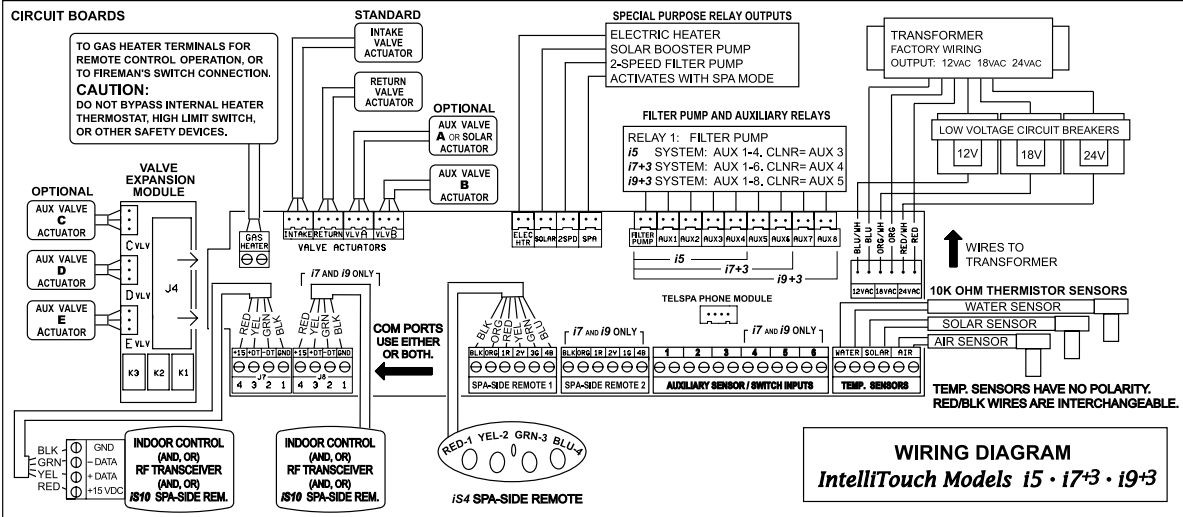

RAINPROOF (TYPE 3R) CONTROL PANEL. FOR INDOOR OR OUTDOOR USE.  
SUITABLE FOR SWIMMING POOL/SPA APPLICATIONS  
120V 125 AMP OR 240V 63 AMP MAX. SINGLE PHASE.  
60 - 75°C. MIN. INSULATION  
SHORT CIRCUIT RATING: 5000 SYMMETRICAL AMPERES.  
TRANSFORMER INPUT: 120V., 2A., 50/60Hz;  
240V., 2 WIRES, 1A., 50/60Hz.

| RELAY CONTACT OUTPUT    |                         |
|-------------------------|-------------------------|
| General: 25A, 277VAC    |                         |
| PUMP                    | LIGHT                   |
| 1.5 HP 120 VAC          | 1.5 KW 120 VAC TUNGSTEN |
| 3 HP 277 VAC            | 4.8 KW 240 VAC TUNGSTEN |
| 20 FLA/120 LRA, 120 VAC | 20A, 277 VAC BALLAST    |
| 17 FLA/102 LRA, 277 VAC |                         |

**PREVENT WATER DAMAGE**  
**KEEP DOOR CLOSED**

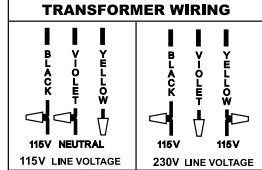

**CAUTION: RISK OF ELECTRIC SHOCK, READ INSTALLATION MANUAL.**  
**IMPORTANT:** This control panel must be installed according to the National Electrical Code (including article 680) and local code requirements. Mount with conduit hole down. The main lugs and neutral main are suitable for No. 14 to 6 AWG COPPER or ALUMINUM conductors for branch circuit wiring. Install interchangeable circuit breakers designed to fit this control panel interior, see list of suitable types below. Follow manufacturers instructions for installing and testing of ground fault circuit breakers (GFCB) and interrupters (GFCI). Additional approved wiring devices may be installed in the rectangular side knockout or inside the enclosure, provided the wiring devices have lead connections. Otherwise, the device with uninsulated terminals must be covered by internally installed metallic or nonmetallic wall box. When using side knockout, an approved rainproof cover must be installed over the wiring device if used outdoors. Make sure connections to low voltage compartment are sound and properly insulated. After wiring, install front panel over wiring compartment and close unused breaker openings with filler plates.



Sanford NC • Moorpark CA



Customer Service 800-831-7133

LABEL P/N 520451 REV. A

Power Center System Wiring Diagram





**⚠ WARNING PREVENT ELECTROCUTION** DISCONNECT ALL CONNECTIONS BEFORE SERVICING THIS UNIT. THIS APPLIANCE HAS UP TO 11 SUPPLY CONNECTIONS.  
 INSTALL AT LEAST 5 FEET FROM INSIDE WALL OF SPA OR POOL

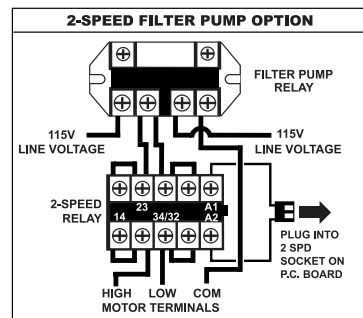
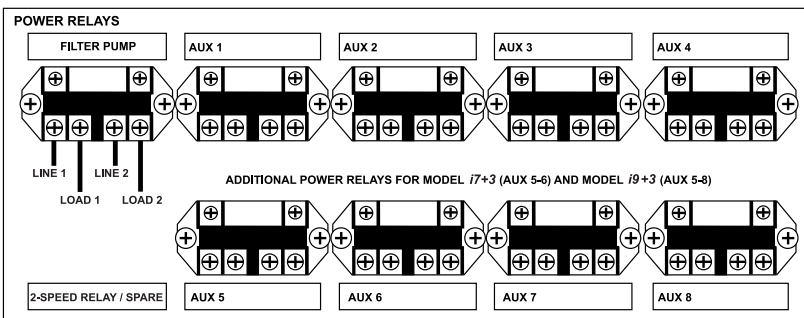
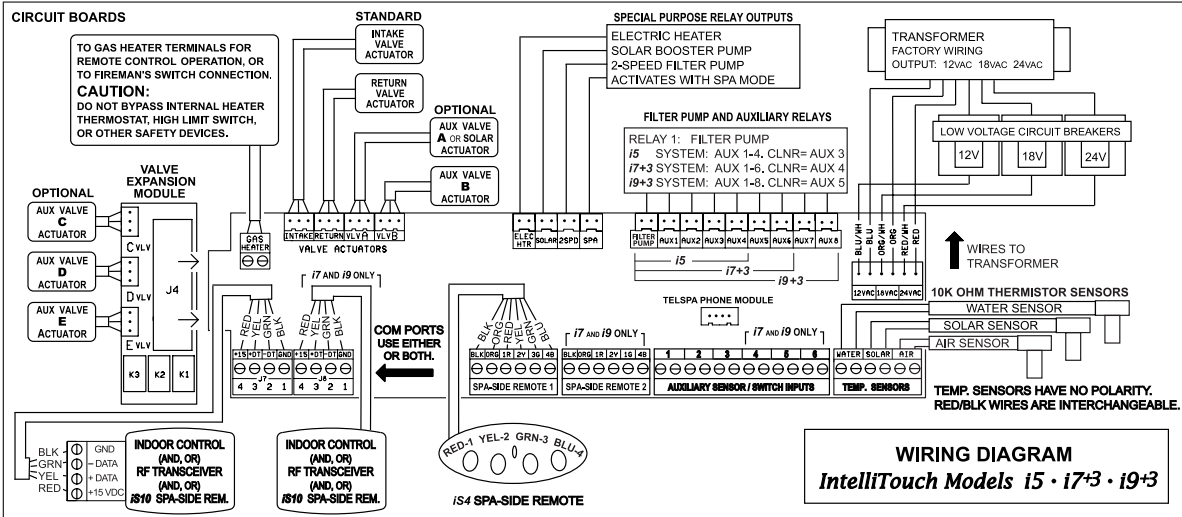

RAINFOOF (TYPE 3R) CONTROL PANEL. FOR INDOOR OR OUTDOOR USE.  
 SUITABLE FOR SWIMMING POOL/SPA APPLICATIONS  
 120V 125 AMP OR 240V 63 AMP MAX. SINGLE PHASE.  
 60 - 75°C. MIN. INSULATION  
 SHORT CIRCUIT RATING: 5000 SYMMETRICAL AMPERES.  
 TRANSFORMER INPUT: 120V., 2A., 50/60Hz;  
 240V., 2 WIRES, 1A., 50/60Hz.

| RELAY CONTACT OUTPUT    |                         |
|-------------------------|-------------------------|
| General: 25A, 277VAC    |                         |
| PUMP                    | LIGHT                   |
| 1.5 HP 120 VAC          | 1.5 KW 120 VAC TUNGSTEN |
| 3 HP 277 VAC            | 4.8 KW 240 VAC TUNGSTEN |
| 20 FLA/120 LRA, 120 VAC | 20A, 277 VAC BALLAST    |
| 17 FLA/102 LRA, 277 VAC |                         |

**PREVENT WATER DAMAGE**  
**KEEP DOOR CLOSED**

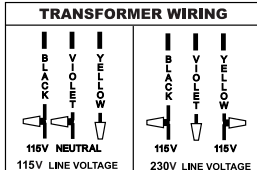

| SUITABLE CIRCUIT BREAKERS |        |
|---------------------------|--------|
| SIEMENS                   | TYPE Q |
| THOMAS & BETTS            | TBXXX  |
| CUTLER HAMMER             | CLXXX  |

**CAUTION: RISK OF ELECTRIC SHOCK, READ INSTALLATION MANUAL.**  
**IMPORTANT:** This control panel must be installed according to the National Electrical Code (including article 680) and local code requirements. Mount with conduit hole down. The main lugs and neutral main are suitable for No. 14 to 2 AWG conductors. Use No. 14 to 6 AWG COPPER or ALUMINUM conductors for branch circuit wiring. Install interchangeable circuit breakers designed to fit this control panel interior, see list of suitable types below. Follow manufacturers instructions for installing and testing of ground fault circuit breakers (GFCB) and interrupters (GFCI). Additional approved wiring devices may be installed in the rectangular side knockout or inside the enclosure, provided the wiring devices have lead connections. Otherwise, the device with uninsulated terminals must be covered by internally installed metallic or nonmetallic wall box. When using side knockout, an approved rainproof cover must be installed over the wiring device if used outdoors. Make sure connections to low voltage compartment are sound and properly insulated. After wiring, install front panel over wiring compartment and close unused breaker openings with filler plates.



Load Center System Wiring Diagram

## Wiring IntelliTouch to a Salt Chlorine Generator

Be sure to check the wire color and function of the salt chlorine generator before connecting it to the IntelliTouch COM port on the Personality board. See the wiring table below for the pin configuration.

Commonly used salt chlorine generator wiring is shown but you should still verify with the manufacturers documentation.

Failure to wire the salt chlorine generator properly can permanently damage the IntelliTouch system or chlorine generator.

### Wiring Description

| <b>IntelliTouch COM port wiring color connection</b> | <b>Description</b> | <b>Salt Chlorine Generator commonly used wire colors</b> |
|--|--------------------|--|
| RED  | +15 VDC            | RED  |
| YELLOW   | + DATA             | BLACK  |
| GREEN  | - DATA             | YELLOW   |
| BLACK  | GROUND             | GREEN  |



## Glossary

## Glossary

**Actuators:** motorized accessory for turning valves and diverting water; model CVA24T.

**Color Set:** Allows a combination of up to 12 SAM, SAL, or Fiberworks lighting circuits to be preset to specific colors.

**Color Swim:** Allows a combination of up to 12 SAM, SAL, or Fiberworks lighting circuits to be preset to transition through colors in sequence. This gives the appearance of colors dancing across your water.

**Component ID:** unique identifier that tells the system what each component is.

**Controller:** Indoor Control Panel or MobileTouch hand-held remote.

**Expansion Kit:** A kit that includes additional auxiliaries to an existing Personality Kit. Requires a Load Center or Power Center for each Expansion Kit.

**Feature Circuits:** programmable circuits that may control relays, macros, and/or valve actuators.

**Firmware:** factory installed operating system software dedicated for use with the IntelliTouch system; each type of control panel has its own firmware and release level.

**Freeze Protection:** turns on a circuit if the air temperature drops below 35° F.

**High Voltage Compartment:** Large lower right compartment of Load Center or Power Center for all high voltage wiring including circuit breakers, relays, and GFCI.

**House Address:** signal that allows Each IntelliTouch system the ability to group all its attached components under a single system identification; prevents the system from confusing its components from components on a neighbor's system.

**ICP:** Indoor Control Panel

**Indoor Control Panel:** fourteen button remote controller with LCD (liquid crystal display) is wired to the Personality board in the Power/Load Center.

**iS4:** Four function Spa-Side remote. Wall or deck mounted.

**iS10:** Ten function spa-side remote with temperature changing capability and display. Wall or deck mounted.

**Load Center:** Metal enclosure with power relays, transformer, and circuit breakers. The Load Center is Installed prior to Personality Kit installation. Used for distributing power for controlling IntelliTouch Systems. Also known as the “sub-panel.”

**Low Voltage Compartment:** Top compartment of Load Center or Power Center for all low voltage wiring.

**Low Voltage Raceway:** Vertical space in the left side of Power/Load Center for low voltage cabling.

**Macro:** Feature circuit that allows you to combine circuits to activate together.

**MobileTouch Controller:** Wireless controller for the IntelliTouch Systems with all the functionality of the Indoor Control Panel.

**Mud Box:** Enclosure to provide mounting features for iS10 spa-side remote that is cast into gunite, concrete, or other spa wall/deck construction.

**Outdoor Control Panel:** Control panel with flexible hinge installed in upper portion of Load Center or Power Center to control IntelliTouch systems.

## Glossary of Terms

**Personality Board:** The circuit board mounted on top of the Outdoor Control Panel motherboard. The Personality board defines the system capabilities.

**Personality Kit:** Set of parts to define the capability of a system. Can include, temperature sensors, actuators, and additional relays, actuators.

**Power Center:** Same as Load Center with the exception of the circuit breaker base.

**Relay Circuits:** The circuits that control the relays on the Personality Board. Connectors on top edge of the circuit board.

**Screw Terminal Connector:** Removable connector that may attach to circuit board with multiple sockets (anywhere from 2 to 12) to receive wires from controllers and sensors; wires held by screw terminals; multiple wires of a small enough gauge (usually 22 AWG) may be coupled to a single socket of a terminal connector.

**Transceiver:** Circuit board with attached antenna that can send and receive radio frequency (wireless) transmissions.

**Screw Terminal:** Removable connector that may attach to circuit board with multiple sockets (anywhere from 2 to 12) to receive wires from controllers and sensors; wires held by screw terminals; multiple wires of a small enough gauge (usually 22 AWG) may be coupled to a single socket of a terminal connector.

**System Personality:** The capability of a system to operate a set of equipment, independent of the kind of controller or other accessories; system personalities include “shared equipment” (i5, i7+3, i9+3), “dual equipment” (i10+3D), or “single body of water” (i5S, i9+3S).

**Temperature Sensor:** Specially designed probe for measuring temperature of the air or pool water; 10 kohm thermistor.

**Terminal Connector:** Removable connector that may attach to PCB with multiple sockets (anywhere from 2 to 12) to receive wires from controllers and sensors; wires held by screw terminals; multiple wires of a small enough gage (usually 22 AWG) may be coupled to a single socket of a terminal connector.

**Two-Speed Pump Relay:** Relay to toggle a two-speed pump from low-speed to high-speed operation; does not turn pump on or off.

**Transceiver:** Special printed circuit board that can send and receive radio frequency (wireless) transmissions.

**QuickTouch QT4:** provides switching of up to four remote control circuits from a wireless Hand-held Remote.

**Valve Module:** Accessory PCB (P/N 520285) to increase auxiliary actuator outputs from two to five.

## Notes

Use this page to take notes or write down important information while you configure the IntelliTouch system. For example, you can write down the names of circuits.



