

THE LITTLE DIPPER™ FUNSLIDE™

SLIDE OWNER'S MANUAL

S.R.Smith™

WORLD LEADER IN SWIMMING POOL DECK ACCESSORIES

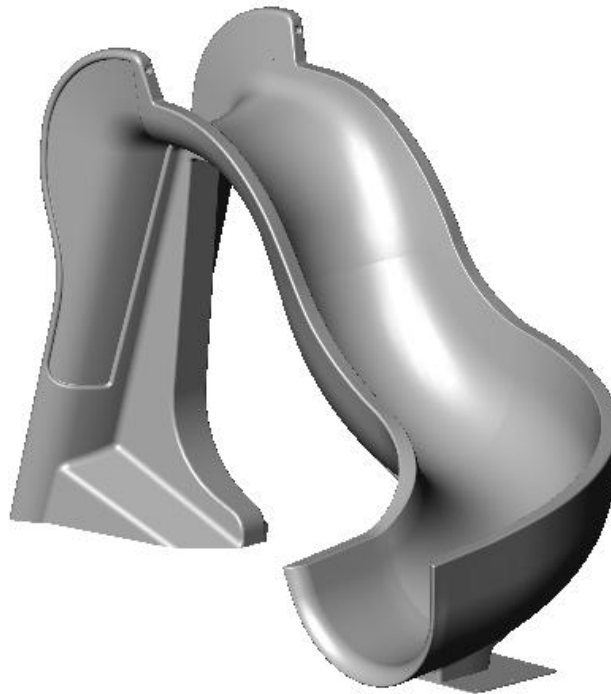

**CORPORATE HEADQUARTERS
WESTERN SALES AND MANUFACTURING PLANT
P.O. Box 400 • 1017 SW Berg Parkway
Canby, Oregon 97013
Phone: (503) 266-2231 • Fax: (503) 266-4334
www.srsmith.com**

Table of Contents

<u>Topic</u>	<u>Page #</u>
Introduction.....	2
Applicable Standards and Codes.....	2
Installation.....	2
Drawings.....	2
Subsequent Owners.....	2
Manufacturer's Placement Instructions.....	3
Installed Slide's Structural & Installation Checklist.....	5
Intended Use Instructions.....	5
Sitting Slide Position.....	6
Do Not Slide Head First.....	7
Daily/Weekly Maintenance Of Slide.....	7
Cleaning Instructions.....	8

INTRODUCTION

S.R. Smith Little Dipper™ FunSlides™ are designed and manufactured for installation and use on swimming pools only. S.R. Smith Little Dipper™ FunSlides™ are NEVER to be installed and used on houseboats, boat docks, floating docks or platforms, on other bodies of water such as lakes, ponds, rivers, etc.

APPLICABLE STANDARDS AND CODES

The installation of the Little Dipper™ Funslide™ must comply with all applicable governmental and building codes.

ASSEMBLY AND INSTALLATION

All S.R. Smith Little Dipper™ FunSlides™ are inspected prior to shipment from the factory. Proper assembly and installation is mandatory. Improper assembly and installation voids S.R. Smith's warranty and may affect the safety of the user. S.R. Smith cannot and does not guarantee customer's deck.

DRAWINGS

All drawings in this Slide Owner's Manual (FIG.'S 1 through 6) are for illustration purposes only and are NOT TO SCALE.

SUBSEQUENT OWNERS

The Owner's Manual must remain with the owner of the slide. If the owner changes, the Owner's Manual shall be brought to the attention of the new owner.

MANUFACTURER'S PLACEMENT INSTRUCTIONS

The Little Dipper™ FunSlide™ owner must confirm that the Manufacturer's Placement Instructions have been followed by the Installer.

1. The critical dimensions for placement of the Little Dipper™ FunSlide™ are as shown in FIG.'S 1 and 2.

- A. The slide exit runway surface shall not exceed twenty inches (20") above the water surface. (see FIG.1)
- B. The slide shall be positioned so that all water flowing off the runway exit drops into the pool. Recommended overhang is 2 inches.
- C. The minimum depth of water below the exit lip of the slide shall be three feet (3') and increases to three feet six inches (3'-6") at Pt. A which is a distance of four feet six inches (4'-6") from the exit lip of the slide. (see FIG.1)
- D. A minimum depth of three feet six inches (3'-6") shall be maintained at a distance of nine feet (9') along the extended centerline of the slide from Pt. A. (see FIG.1)

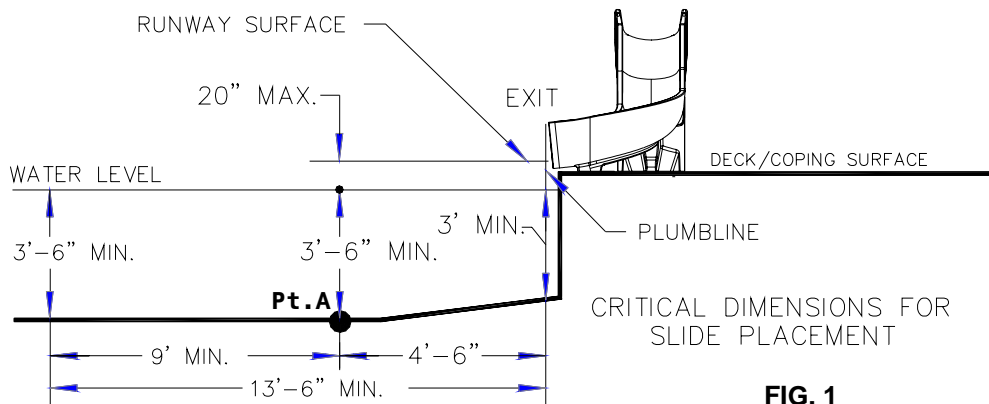

FIG. 1

2. A minimum clearance area in front of the slide shall be maintained away from the coping, another slide, a diving board or a rope and float line. (see FIG.4)

- A. The minimum clearance distance on either side of the extended centerline of the slide runway shall not be less than three feet six inches (3'-6") at a point no less than two feet six inches (2'-6") from the exit lip of the slide and extending a distance of thirteen feet six inches (13'-6") in front of the slide. (see FIG.2)
- B. The minimum clearance area in front of a diving board is a minimum distance of three feet six inches (3'-6") on either side of the board's centerline. Pt. C extends a minimum distance of "C" from the tip end of the board. The width distance "W" on either side of Pt. C is given in CHART 1 and shown in FIG.3.

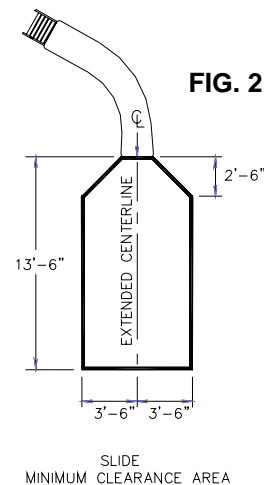

FIG. 2

CHART 1

BOARD MINIMUM CLEARANCE AREA		
POOL TYPE	"C" DIMENSION	"W" DIMENSION
I	14'-6"	5'-0"
II	14'-6"	6'-0"
III	16'-6"	6'-0"
IV	18'-6"	7'-6"
V	21'-0"	7'-6"

See Article 5 contained in ANSI/NSPI-5 2003 STANDARD FOR RESIDENTIAL INGROUND SWIMMING POOLS and refer to FIGURE 3 and Table 1 for Minimum Water Envelope Dimensions AB, BC and Width at Point C.

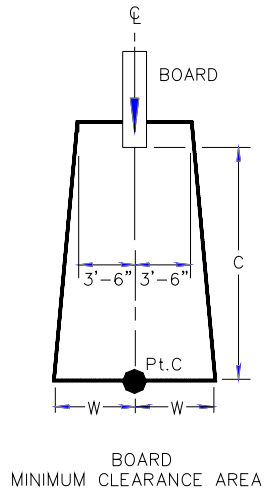

FIG. 3

"C" DIMENSION FOR BOARD = AB + BC
 "W" DIMENSION FOR BOARD = WIDTH AT PT.C

C. The minimum clearance area of a slide or diving board shall not intersect any coping or rope and float line. (see FIG.4) The minimum clearance area of a slide or diving board may intersect each other provided that they are not used simultaneously.

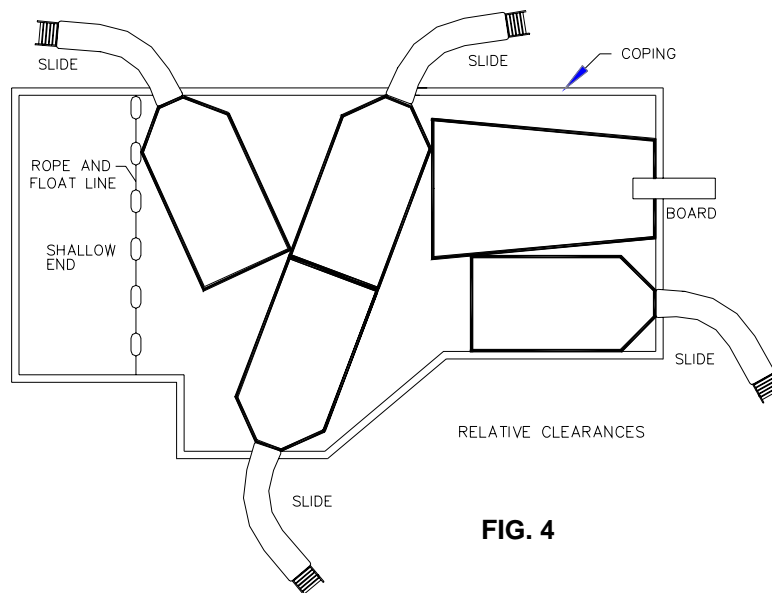

FIG. 4

INSTALLED LITTLE DIPPER™ FUNSLIDES™ STRUCTURAL & INSTALLATION CHECKLIST

After installation and prior to the first use of the Little Dipper™ FunSlide™ and periodically thereafter the owner must:

1. Inspect the runway for visible cracks or tears.
2. Inspect the ladder for sharp edges, protrusions, cracks or tears.
3. Inspect ladder mounting bracket and runway mounting plate for loose or corroded fasteners.
4. Measure the following dimensions and compare with the Manufacturer's Placement Instructions on pages 3 and 4.
 - Measure the depth of water in front of the slide exit. (3-6" min. depth at a distance of 4-6" from exit end of slide.)
 - Measure the height of the slide runway exit above the water. (20" max.)
 - Measure the distance between the slide centerline and the edge of other pool equipment.
5. Observe the position of the exit of the slide as shown in FIG.'S 2, 3 and 4 on pages 3 and 4.

INTENDED USE INSTRUCTIONS

**** IMPORTANT ****

READ AND FOLLOW THE SIMPLE SAFETY RULES BELOW.

MAKE SURE THAT EVERYONE WHO USES THE LITTLE DIPPER™ FUNSLIDE™ KNOWS AND FOLLOWS THESE RULES.

ENFORCE THESE RULES WITH ADULT SUPERVISION

Installed and used properly, the Little Dipper™ FunSlide™ will give you, your family, friends and guests many hours of enjoyment. Like any other piece of equipment however, the Little Dipper™ FunSlide™ can be misused in such a way as to cause the user injury, even serious and crippling injury. As the owner of a Little Dipper™ FunSlide™ it is your responsibility to do the following:

1. Only one person allowed on the slide at any given time.
2. Roughhousing or horseplay on the slide is strictly forbidden.
3. Do not use the slide as a diving platform. The slide is made for sliding only, not diving.
4. Familiarize yourself with the shape of the pool bottom and the water depth before you slide. Use the correct slide configuration shown on the ladder when sliding.

5. Avoid sliding until all submerged obstacles, surface objects or other swimmers are clear of the slider's pathway.
6. Don't slide at or through objects such as inner tubes, as they force the slider deeper increasing the potential of a crippling injury.
7. Don't drink alcoholic beverages and slide.
8. Don't slide alone; use the buddy system.
9. The slide is a water slide and should be installed only according to the instructions on pages 3 and 4 of this manual. Don't allow children to use the slide without adequate supervision. Users must be swimmers.
10. Take your time in preparing to slide. Move forward slowly and get yourself positioned properly before starting the slide.
11. Handicapped persons should use caution and may require supervision.
12. Do not use the slide if any part of it becomes damaged, weakened, or broken. Don't take chances. Have the slide inspected and, if necessary, repaired by a competent professional, who is familiar with water slides before using the Little Dipper™ water slide again. See INSTALLED SLIDES' STRUCTURAL & INSTALLATION CHECKLIST on page 5.
13. Individuals who exhibit frailty due to age should not use the slide.
14. People with history of back problems, heart conditions or fear of heights should not use the slide.
15. People who weigh over 150 pounds should not use the slide.
16. Women who are pregnant should not use the slide.
17. Don't use any other sliding technique, other than the following:

SITTING SLIDE POSITION

In the sitting slide position, face forward on the slide holding the legs and arms straight out with the palms of your hands tilted upward. (see FIG. 5)

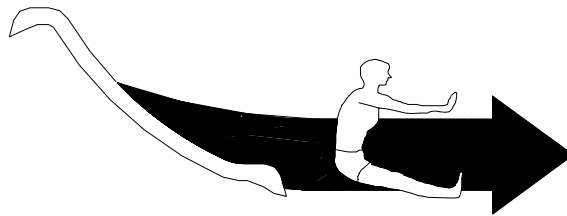

FIG. 5

**** IMPORTANT ****

In order for a person to minimize the possibility of injury, **HEAD FIRST SLIDES ARE STRICTLY PROHIBITED.** (see FIG. 6) It is necessary that the user know that the chief danger of this type of slide is serious spinal injury. Injuries to the spine may result in temporary or permanent paralysis or even death. Research studies have shown that you cannot rely on the water to slow you down sufficiently to avoid injury.

As a Little Dipper™ FunSlide™ owner, it is your responsibility to explain the nature of this danger to all persons who may use your Little Dipper™ FunSlide™, since they may not otherwise appreciate the dangers of performing head first slides.

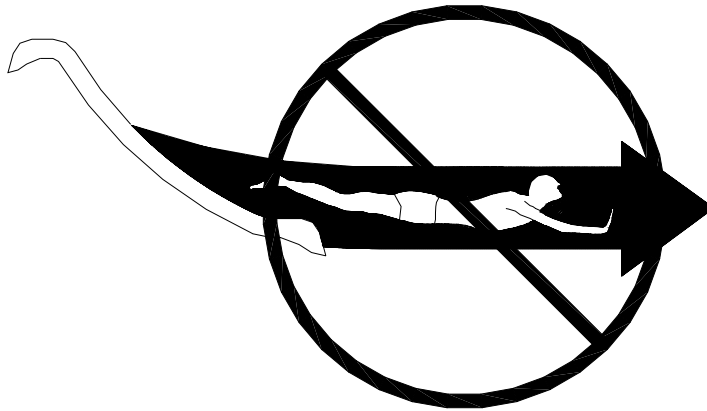

FIG. 6

DO NOT SLIDE HEAD FIRST

DAILY/WEEKLY MAINTENANCE OF THE LITTLE DIPPER™ FUNSLIDE™

1. When hosing down the deck, hose your Little Dipper™ FunSlide™ to wash away any dust, dirt or other debris, which may have accumulated.
2. Be sure that the connection between the slide runway and ladder is secure. Tighten hardware if necessary.
3. All powder coated parts require little maintenance. Hose and wipe to clean. While cleaning powder coated parts, check and see that all nuts and bolts are tight and secure.

CLEANING INSTRUCTIONS

Use Nonabrasive soap and water when possible. In addition, you may safely use: Always try a test spot before applying to a large area.

Windex® With Ammonia
Soft Scrub®
Glass Plus®

Formula 409®
Scrubfree
Topjob®

Fantastik®
Tackle®
Tilex®

Always read the label instructions on any cleaner carefully before applying it to a *polyethylene* surface.

AVOID HARSH CHEMICALS AND DISINFECTANTS. DO NOT USE:

Dow with Scrubbing Bubbles®
Windex® With Vinegar
White Cap®

Lysol® Disinfectant
White Cap®

Ajax® Cleanser
Ajax® Liquid